

# 2024



Thread Milling

Thread Turning

Milling

Drilling

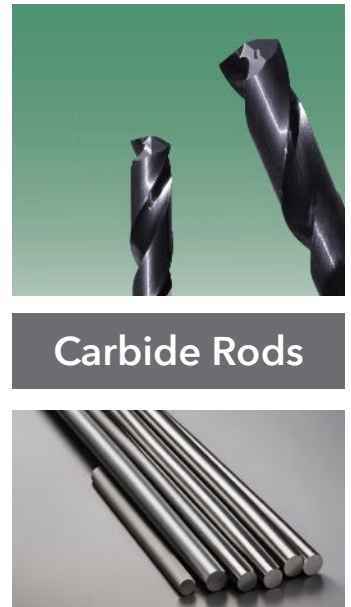
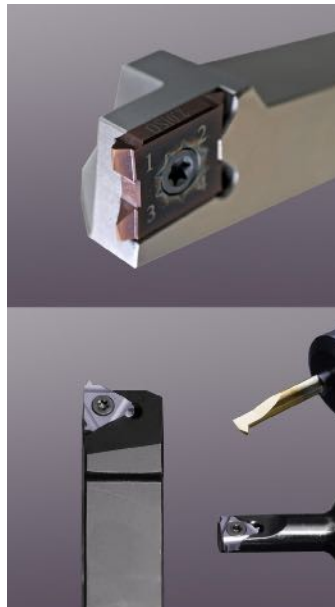
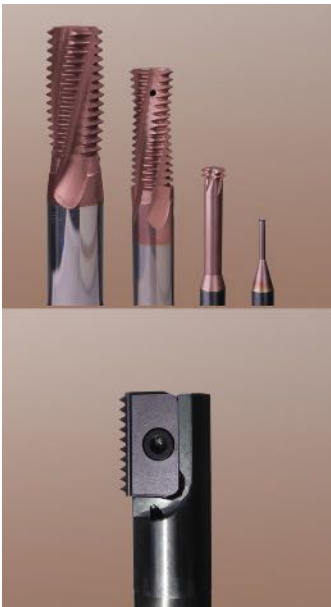

# Cutting Tools

## Main Catalogue

# NEWS

## New Products for this Catalogue

### Vibration-Free Thread Mills

page 6-7

New tools with more flutes that provide vibration-free machining when used at the correct thread length.

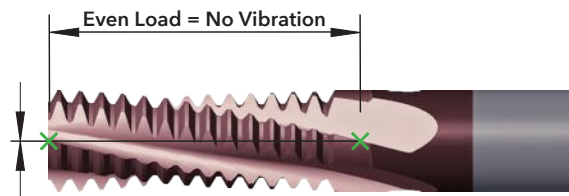

### LC - New FourCut Grade

page 43

LC is a new standard grade. We recommend this grade as the first choice for many different materials such as steel, cast iron and aluminium. Use HC as first choice for materials such as stainless steel and harder materials.

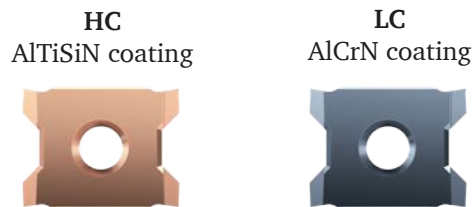

Choose between the grades HC and LC for maximal productivity.

## 3D Cad Drawings available for Thread Mills and FourCut

SmiCut has created simplified 3D CAD files for the complete FourCut program as well as our Solid Carbide Thread Mills. These are available as STEP files which can be downloaded at no cost from the SmiCut Online Store.

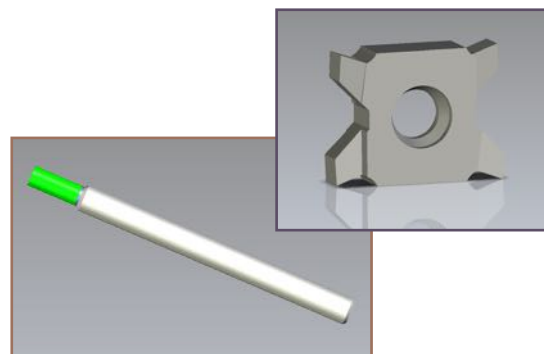

## About Us

SmiCut, founded by the Schmidt family in 1995, is a global leader in the development, manufacturing, and supply of cutting tools. The Schmidt family began creating threading tools over 60 years ago. Now involving three generations, the company stays committed to its primary product – threading tools, providing superior solutions. Known for innovation and quality, SmiCut, located in Sweden, is proud to serve clients around the globe.

# CONTENTS



## Thread Milling Tools *page 3*

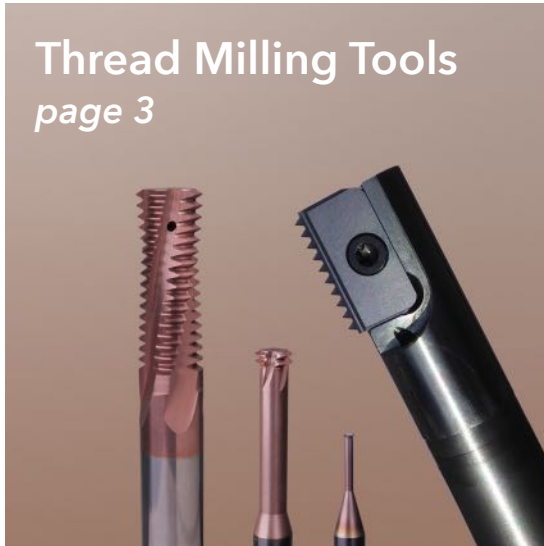

## Thread Turning Tools *page 39*



## Solid Carbide End Mills *page 72*



## Solid Carbide Drills *page 111*

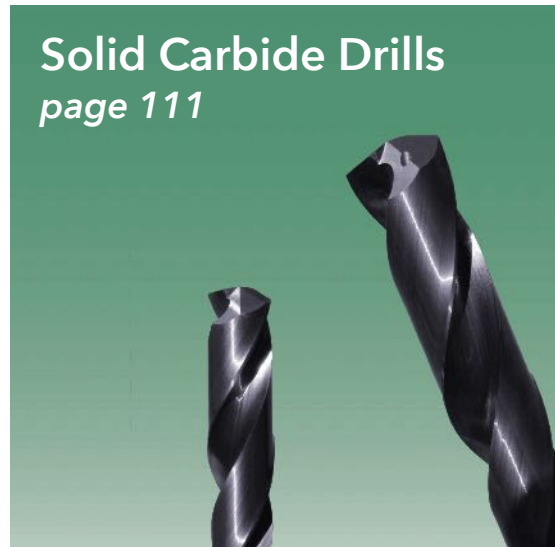

## Carbide Rods *page 123*

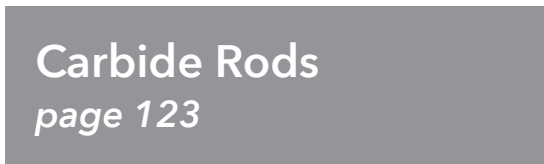

## Thread Designations *page 126*

# ThreadBurr

*The Master of Threading*

Threading and deburring  
in one operation



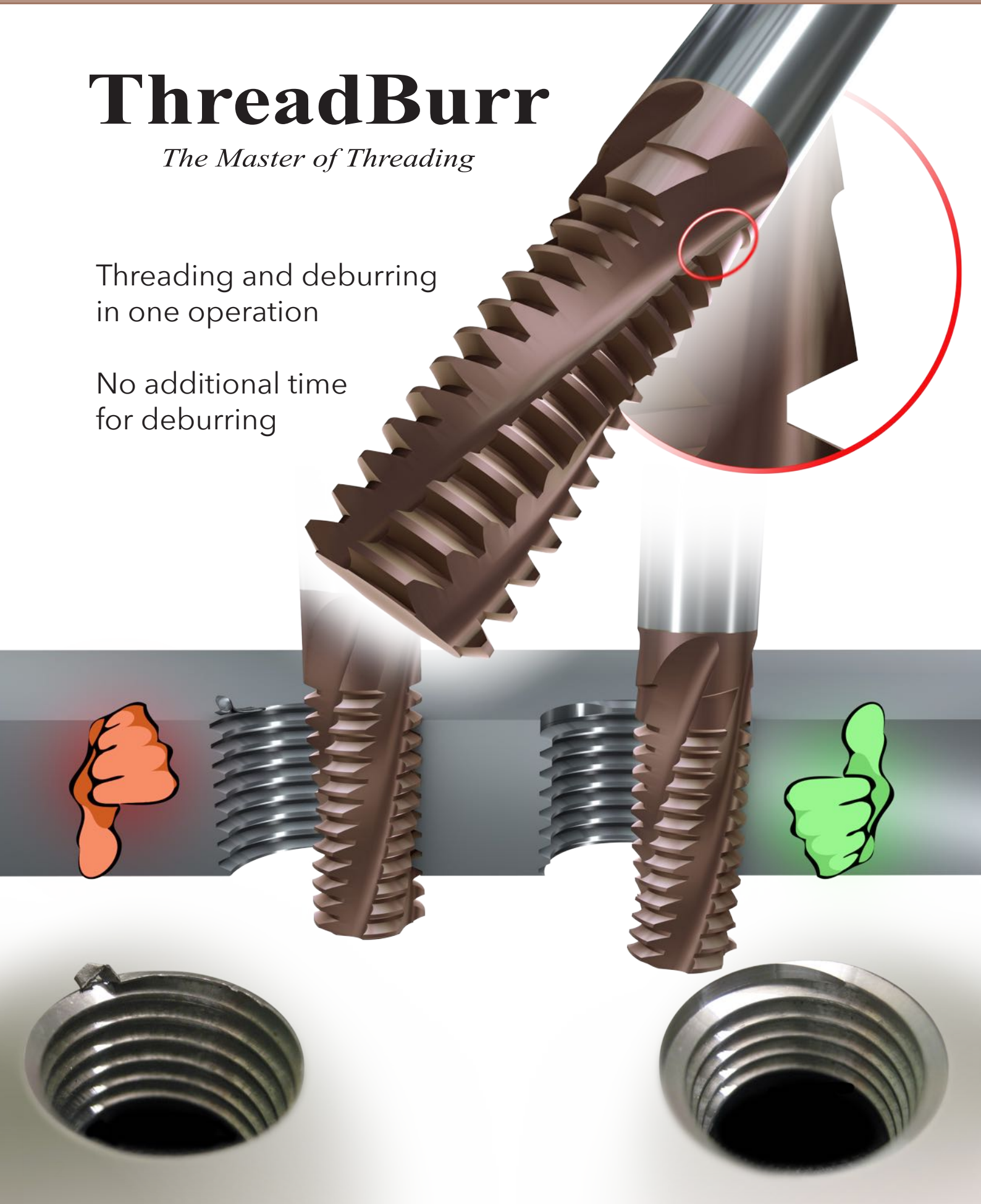





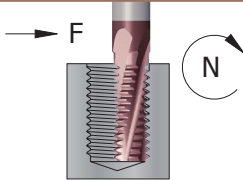

No additional time  
for deburring



# THREAD MILLING

## CONTENTS

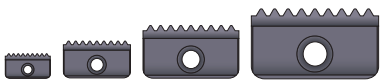
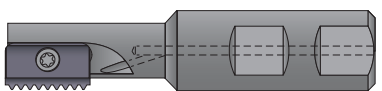

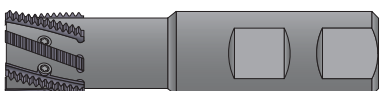
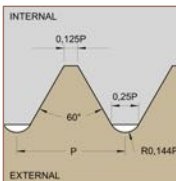
Technical Information	4	
Solid Carbide Thread Mills, ThreadBurr		
without Internal Coolant	16	
with Internal Axial Coolant	24	
with Internal Radial Coolant	25	
Solid Carbide Thread Mills		
with One Tooth	26	
with Two Teeth	28	
with Chamfer	29	
Tapered End Mills for NPT/NPTF/BSPT	23	
Thread Mills with Straight Inserts		
Straight Fluted Inserts	30	
Toolholders	32	
Thread Mills with Spiral Inserts		
Spiral Fluted Inserts	34	
Toolholders	36	
Thread Designations	126	
Common Thread Profiles	129	



### Why choose Thread Milling instead of Tapping?

#### 1. A secure machining operation

Minimal risk of machine stoppages as the cutting forces are low and the chips are short. The work piece will not be destroyed in case of tool failure, as the tool will not get stuck since the diameter of the thread mill is smaller than the thread.

Tap breakage can easily destroy expensive workpieces, since threading is often the last operation on the part.

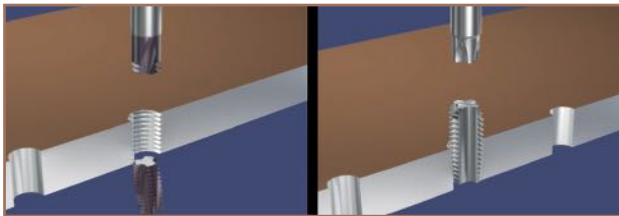

Milling

Tapping

#### 2. Difficult machined materials

The excellent cutting conditions with low cutting forces makes it possible to thread mill materials such as hardened steel up to HRC 65, Titanium and other difficult machined materials.

Laser cut holes becomes more common. Threading with a tap is difficult because the surface has become hard, but with a thread mill it is easily done.



Milling

65 HRC



Tapping

#### 3. Different tolerances

Very tight tolerances are possible to get by using radius correction in the CNC-program.

With taps you need different tools for different tolerances. The tap is used up after wear, but with a thread mill you can continue threading after adjusting with radius compensation.

If you make a surface treatment, special taps must be used, if not the threading has to be made afterwards to get correct tolerance. With a thread mill, the thread can be made before treatment. No machining is needed after the treatment and the thread is protected against rust and wear.

#### 4. Better thread quality

The cutting conditions are optimal when thread milling. The chip evacuation is very good as the tool diameter is smaller than the thread diameter. The thread will have very good surface finish and quality.

When tapping, the tool size is the same as the thread size and the tap has to force the chip through the thread. The result is a thread that may not be good enough.



#### 5. Flexible tool

Same cutter can be used for both right hand and left hand threads. Threads with different diameters and tolerances can be made with the same tool as long as the pitch is the same. The same thread mill can be used for blind holes and through holes. W, BSPT, PG, NPT, NPTF and NPSF are thread profiles where you can use the same tool for external and internal threads.

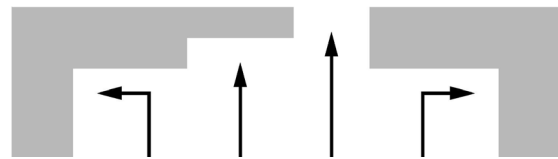

#### 6. Threading in blind holes

With thread milling, a full thread profile is obtained all the way to the bottom of the hole. This allows you to make a thread where it is usually not possible.

With tapping it is necessary to drill much deeper as it is only from the third thread you get the complete thread profile.

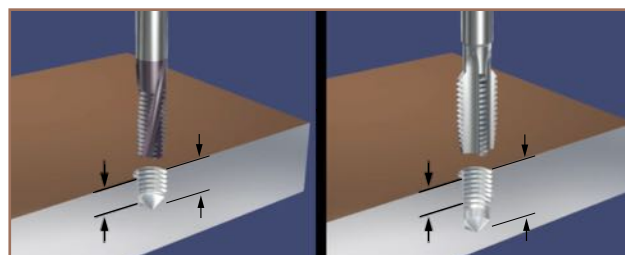

Milling

Tapping

## Advantages

### Why choose Thread Milling instead of Tapping?

#### 7. Threading in thin-walled components

No deflection of the material when thread milling thin-walled components as the cutting forces are low.

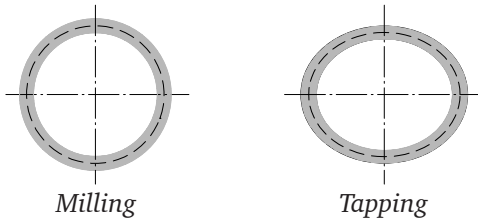

#### 8. Threading without burrs

The thread entrance will be burr free when using ThreadBurr. Threading and deburring in one operation. No additional time for deburring.

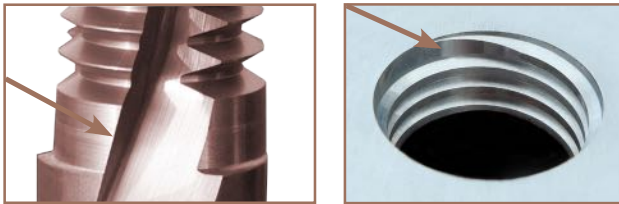

#### 9. Shorter machining time

Tapping is normally considered as a quicker method than milling. That is correct in small coarse threads if you do not take in consideration the time for chamfering.

The machining time will be short while using ThreadBurr as the thread will be deburred when threading, so chamfering is not necessary to get a good thread. Big diameters, fine pitches and long threads saves most time compared with tapping.

If you have threads with the same pitch you will save time in tool changes as you can use the same thread mill for different diameters.



#### 10. Threading in smaller machines

As the cutting forces are low it is possible to make large threads and big pitches in less powerful machines.

#### 11. Less wear on the machine spindle

Thread milling result in longer service life of the machine spindle compared with tapping as the rotation on the spindle does not need to be stopped and reversed for every thread.



#### 12. Energy-saving production

Low energy consumption as the machine spindle does not need to be stopped and started for reversing.



#### 13. Threading in a lathe with live tools

Thread milling reduce machining time compared with thread turning. Excellent chip control minimizes the risk of tool failure.

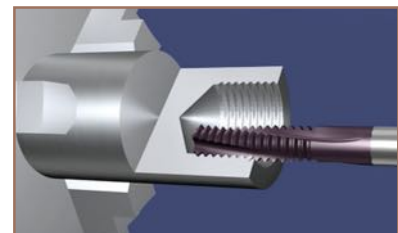

#### 14. Correct Thread Diameter right away

The Pitch diameter has been optically measured on thread mills from SmiCut and the theoretical external diameter has been individually laser marked on each cutter so you get a thread in tolerance right away. When the tool starts to wear it is possible to make adjustments in the CNC-program.

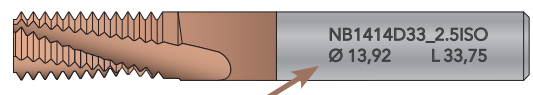

Theoretical external diameter is laser marked

# THREAD MILLING

## Vibration-Free Machining

### How Tool Design Impacts Vibrations

To achieve a vibration-free tool, it is important to maintain consistent cutting force and tool load throughout the entire process.

If the cutting edge leaves too early, it will result in an irregular tool load, causing vibrations.

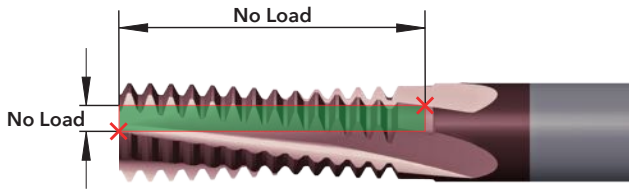

*This Thread Mill is not Vibration-Free*

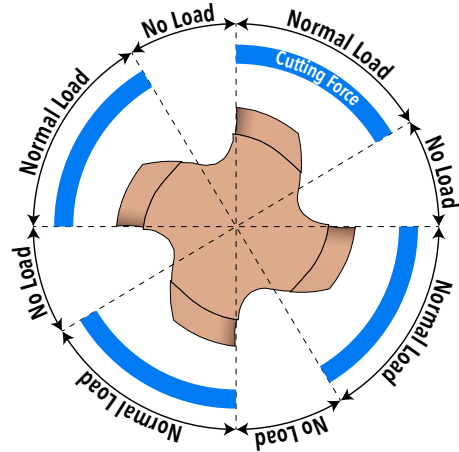

If it leaves too late, in addition to the irregular load, you will experience a very high load due to two flutes cutting simultaneously.

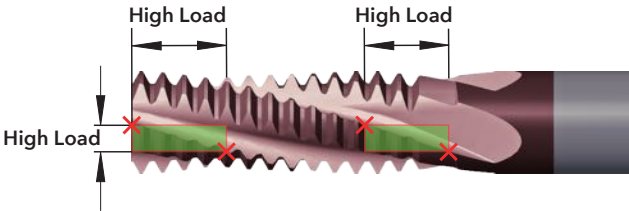

*This Thread Mill is not Vibration-Free*

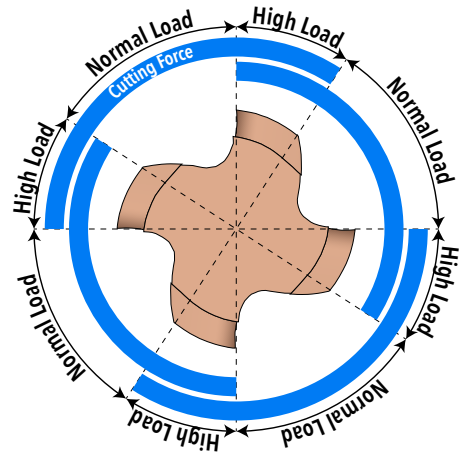

### SOLUTION

To achieve a vibration-free tool, the cutting edge should not leave the material until the cutting edge from the next flute starts entering the material.

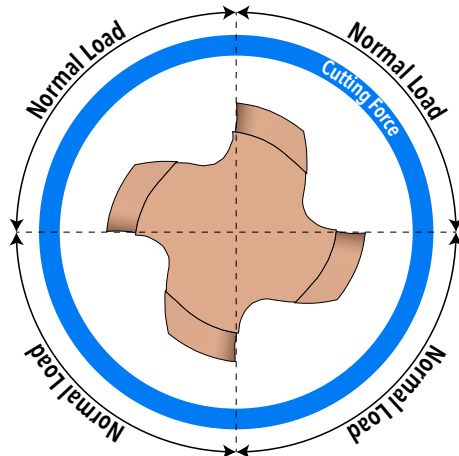
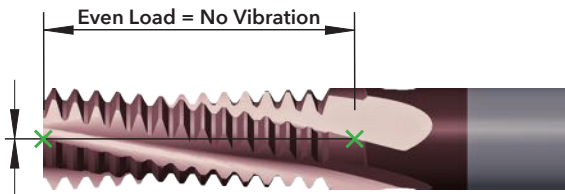

*This Thread Mill has the optimal helix angle, tool diameter and number of flutes to ensure Vibration-Free machining when using the entire cutting length.*



## Vibration-Free Machining

### How SmiCut Design Vibration-Free Thread Mills

The following parameters will affect whether the tool can achieve vibration-free machining:

- **Thread Length** Thread length is difficult to change, as it is mostly determined by the drawing.
- **Tool Diameter** Tool diameter is always the same for coarse threads since they are designed to be as strong as possible.
- **Number of Flutes** It is possible to increase the number of flutes for vibration-free machining, but keep in mind that some materials may present chip flow problems.
- **Helix Angle of Tool** The helix angle of the tool can be varied slightly. Our experience shows that 15° is optimal, but good results can be obtained between 12° and 18°.

With this in mind, SmiCut has designed new tools that, under the appropriate conditions will provide vibration-free machining when used at the correct thread length. Short thread lengths should have more flutes.

Thread Length	New Design	Old Design	
1,5xD	5 flutes	3 flutes	2 flutes more
2xD	4 flutes	3 flutes	1 flute more
2,5xD	3 flutes	3 flutes	Same as before
3xD	3 flutes	3 flutes	Same as before

*With more flutes, you will experience less vibration, shorter machining time, longer tool life, and better economy.*

### Reduce Vibrations with Proper Programming

When you have problems with vibrations you normally increase number of passes. Instead of making the thread in one pass you may do it in two or three passes.

The most common way is to make the first pass at a smaller diameter and then increase the diameter to the correct size for the last pass. This will result in a radial infeed with chips that are difficult to break and may not reduce the vibrations as much as you want.

To avoid this you should not only change the diameter for the extra passes. You should as well change the level for them (Z). If you do this you will get a flank infeed with easily broken chips and less vibrations. The software SmiProg will give you correct infeed for multipasses.

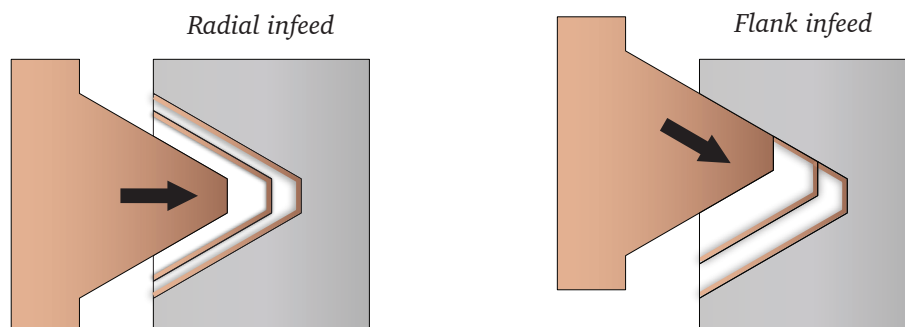

*Thread Milling with three passes. Use flank infeed to reduce vibrations. SmiProg gives the data for flank infeed when you make the thread in multipasses.*

# SOLID CARBIDE THREAD MILLS

## ThreadBurr

### Threading & Deburring in one operation

The advantage with ThreadBurr is that you can thread and deburr in one operation. No additional time for deburring and countersink is needed. The deburring operation is made automatically when thread milling, which gives you the deburring without any extra costs.

There is no disadvantage to use the ThreadBurr, even if you do not use the deburring function. ThreadBurr is standard on all thread mills from SmiCut.

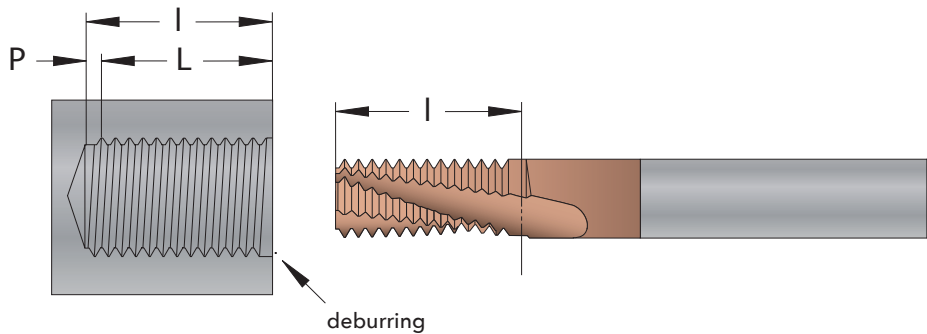

To get a nice entry and a burr free thread you need to start out with going to full depth (L) in to the hole before starting the threading operation. The thread length (L) will be the cutting length (L) minus one pitch (P).

### Double ThreadBurr

It is possible to get the thread deburred on both sides. For this operation you need to use a special tool as thread length depends on the thickness of the material. Have in mind the following when you order a tool for deburring on both sides.

- The cutting length (L) should be equivalent to the thickness of the material.

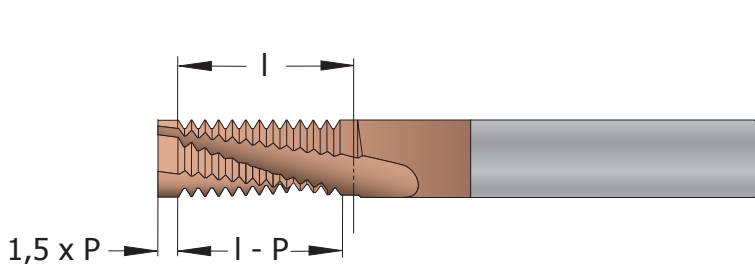

### Example

M30x3 thread length 40 mm

$40 / 3 = 13,3$       Number of pitches  
 $13 \times 3 = 39,0$       Cutting length (L)

Thread Milling with NBB2020D39\_3.0ISO\_AC (L = 39,0 mm)

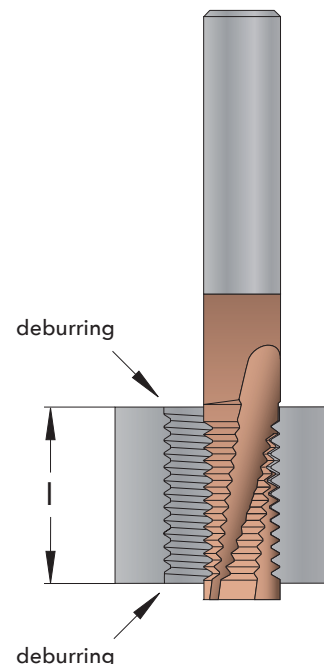

## ThreadBurr

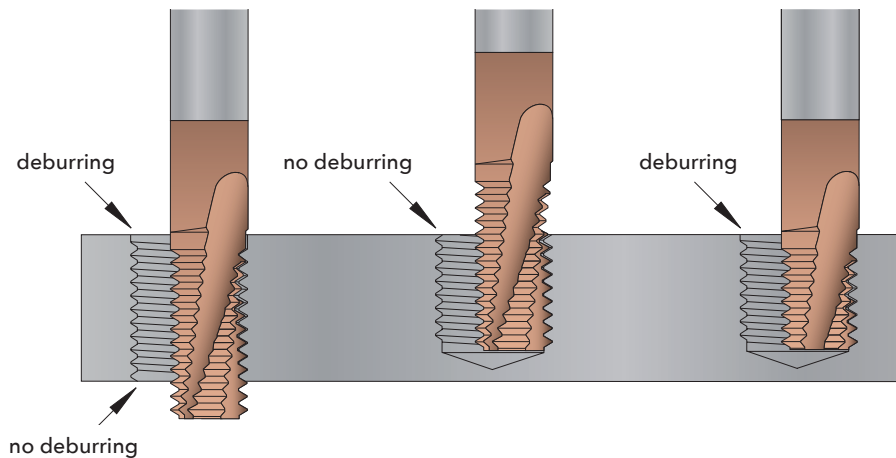

## Through Holes

You can always use a standard tool for through holes. Please take in mind you should use a tool as short as possible to get best stability and economy.

## Blind Holes

With blind holes it is important to have the correct cutting length (l) on the tool to get the thread deburred. Normally you will find a suitable standard tool. If not, we will cut the tool to the correct length with extremely short delivery time and at a reasonable price. Have in mind the following when you order a tool for blind holes.

- The cutting length (l) should be required thread length (L) plus one pitch (P).
- The distance to cut off (c) has to be dividable by the pitch (P).

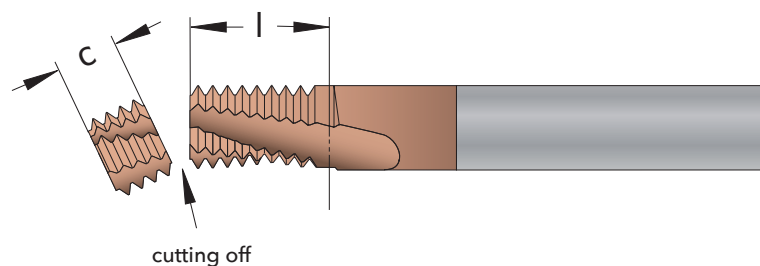

## Example

M16x1,5 thread length 24 mm  
Thread Milling with NB1212D29\_1.5ISO\_AC (L = 29,25 mm)

$24 + 1,5 = 25,5$ mm	Required cutting length (l)
$29,25 - 25,5 = 3,75$ mm	Maximum cutting off
$3,75 / 1,5 = 2,5$	Number of pitches to cut off
$2 \times 1,5 = 3,0$ mm	Distance to cut off (c)
$29,25 - 3,0 = 26,25$ mm	Cutting length (l) after cutting off
$26,25 - 1,5 = 24,75$ mm	Thread length (L) after cutting off

You only need to cut off the tool when you want to use the deburring function on blind holes and if there is no standard tool with suitable cutting length.

### How to choose correct Thread Mill Diameter

When thread milling, the diameter of the tool has to be smaller than the thread diameter. The reason for this is that the thread has a helix angle, but the tool is straight. If the tool is too big there will be a deviation on the thread profile. The size of this deviation depends on several parameters.

1. Thread diameter
2. Cutter diameter
3. Profile angle
4. Pitch

Big cutter diameter compared to thread diameter, small profile angle, and big pitch are parameters that give greater deviation.



There are three alternatives too choose correct thread mill diameter.

1. SmiCut Catalogue
2. SmiCut Online Store, [smicut.store](http://smicut.store) (see page 11)
3. SmiProg Software, [smicut.com](http://smicut.com) (see page 12)

### How to get correct Thread Diameter

The pitch diameter of thread mills from SmiCut has been optically measured and the theoretical external diameter has been individually laser marked on each cutter. This diameter is what you should use in your program to get a correct diameter on your thread.

For coarse threads you are normally in the middle of the tolerance if you use the laser marked value.

Fine threads may be a little bit tight as you get a very small thread profile deviation on these threads (see above). If this is the case you can mill again after adjusting the diameter in your program.

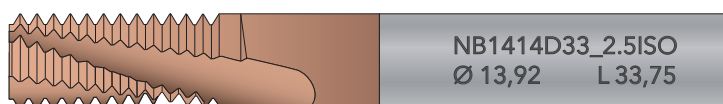

### How to get a burr free Thread

Thread Mills from SmiCut (ThreadBurr) will give you a nice entry and a burr free thread. The cutting length is laser marked on the tool and you can find it as well in the catalogue. This is the distance you should go in to the hole from the surface to get a perfect entry.

## Select correct Thread Mill

### SmiCut Store helps you find suitable tools

If you need a Thread Mill for a specific thread and you need help to find the correct tool, just go to [smicut.store](http://smicut.store) and you will very quickly find suitable tools.

Example: M16 with thread length 32 mm

1. Choose THREAD MILLING Application on the left side
2. Choose M - Metric coarse
3. Choose M16
4. Choose what kind of tool you want, for example without coolant

Now you can see all solid carbide thread mills without coolant that are able to produce M16. From these ones you have to take a tool with a cutting length of at least 32 mm. You can see the cutting length on the part number (see page 13 for more information about "code key"). The most suitable tool is NB1212D35\_2.0ISO\_AC. If you want complete information about the dimensions press on the part number of the tool.

You are as well able to do this thread with a tool with a smaller diameter or longer thread length, but this result in longer machining time and/or not as good cutting conditions. Sometimes you choose this anyhow as you may already have the tool, the price is less or you want to have a tool that can make different sizes of threads.

To check machining time and cutting conditions for different tools, please use "SmiProg" (see next page).

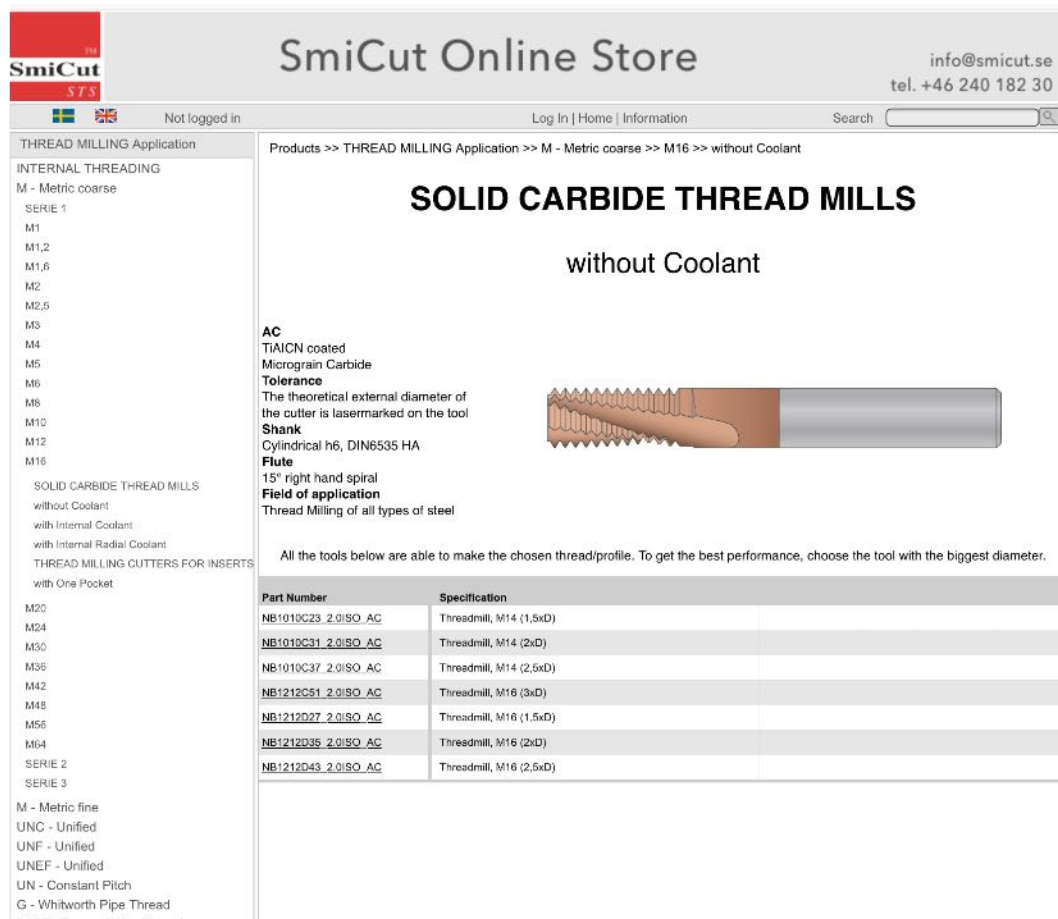

The screenshot shows the SmiCut Online Store interface. The main heading is "SOLID CARBIDE THREAD MILLS without Coolant". The left sidebar lists various thread mill applications and series. The main content area displays technical specifications for the selected tool, including material (TiAlCN coated Micrograin Carbide), tolerance, shank, and flute details. A table lists several part numbers and their specifications.

**AC**  
TiAlCN coated  
Micrograin Carbide

**Tolerance**  
The theoretical external diameter of the cutter is lasermarked on the tool

**Shank**  
Cylindrical h6, DIN6535 HA

**Flute**  
15° right hand spiral

**Field of application**  
Thread Milling of all types of steel

All the tools below are able to make the chosen thread/profile. To get the best performance, choose the tool with the biggest diameter.

Part Number	Specification
NB1010C23 2.0ISO AC	Threadmill, M14 (1,5xD)
NB1010C31 2.0ISO AC	Threadmill, M14 (2xD)
NB1010C37 2.0ISO AC	Threadmill, M14 (2,5xD)
NB1212C51 2.0ISO AC	Threadmill, M16 (3xD)
NB1212D27 2.0ISO AC	Threadmill, M16 (1,5xD)
NB1212D35 2.0ISO AC	Threadmill, M16 (2xD)
NB1212D43 2.0ISO AC	Threadmill, M16 (2,5xD)



### SmiProg makes it easy to Thread Mill

Specify control system, material, thread diameter, pitch and thread length. The program will recommend suitable tools. Choose one and you will receive suggested cutting data, time to mill the thread and CNC programming code. The software is made in excel and includes 22 different languages. Download SmiProg free of charge at [smicut.com](http://smicut.com). SmiProg is also available as a web app which makes it easy to use on a wide range of devices.

### Thread Milling

Internal Thread Milling in Machining Center

Fanuc

M - Metric

Steel, Low Carbon, < 0,25% C, < 400 N/mm2

**D = thread diameter (mm)**  1

**P = pitch (mm)**  2

**L = thread length (mm)**  3

**S = safety distance (mm)**  4

NB08075C21\_1.5ISO\_AC

**d = cutter diameter (mm)**  5

**l = length of cutting edge (mm)**  6

**z = number of flutes**  7

**V = cutting speed (m/min)**  8

**Fz = feed/tooth (mm/tooth)**  9

**Number of passes, radial (max 3)**  10

**Number of passes, axial**

**N = spindle speed (rpm)**

**FD = feed at thread diameter (mm/min)**

**Fd = feed in center of mill (mm/min)**

**T = time to mill the thread (seconds)**

[Please read before use!](#)

**CNC program for Fanuc**

```
S6706 M3
G00 G91 Z-22.
G01 G41 X0.625 Y-0.625 F53
G03 X0.625 Y0.625 Z0.188 I0. J0.625
G03 X0. Y0. Z1.5 I-1.25 J0. F106
G03 X-0.625 Y0.625 Z0.188 I-0.625 J0. F530
G01 G40 X-0.625 Y-0.625
G00 Z20.124
```

info@smicut.se  
www.smicut.se  
Tel +46 240 182 30

copyright ©  
2021-09-29

English

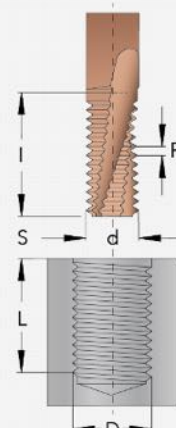

Choose among these languages

- Chinese (simp.)
- Chinese (trad.)
- Czech
- Danish
- Dutch
- English
- Estonian
- Euskera
- Finish
- French
- German
- Hungarian
- Italian
- Japanese
- Korean
- Norwegian
- Polish
- Portuguese
- Romanian
- Russian
- Spanish
- Swedish

### SmiProg - Tutorial Video Series

Learn how to use SmiProg and our Thread Mills with video tutorials. They are available in various languages.

**Part 1:** Introduction (2:38)

**Part 2:** The Basic Features (6:23)

**Part 3:** ThreadBurr & Correct Diameter (4:49)



### Thread Milling - FAQ

Visit our website and check out the valuable FAQ page that provides many good answers to questions about thread milling. This webpage, available in many languages, includes the following categories:

- General questions about thread milling
- Questions about different threads and thread profiles
- Questions about different types of thread mills

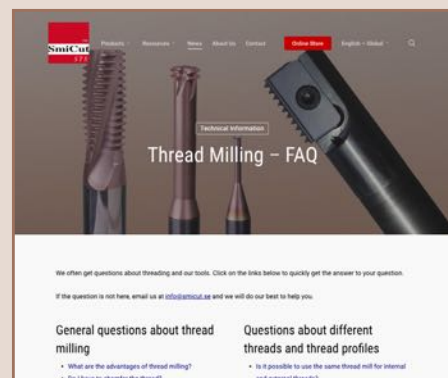

# THREAD MILLING

## Code Key



### Smart Part Numbers with Tool Specifications

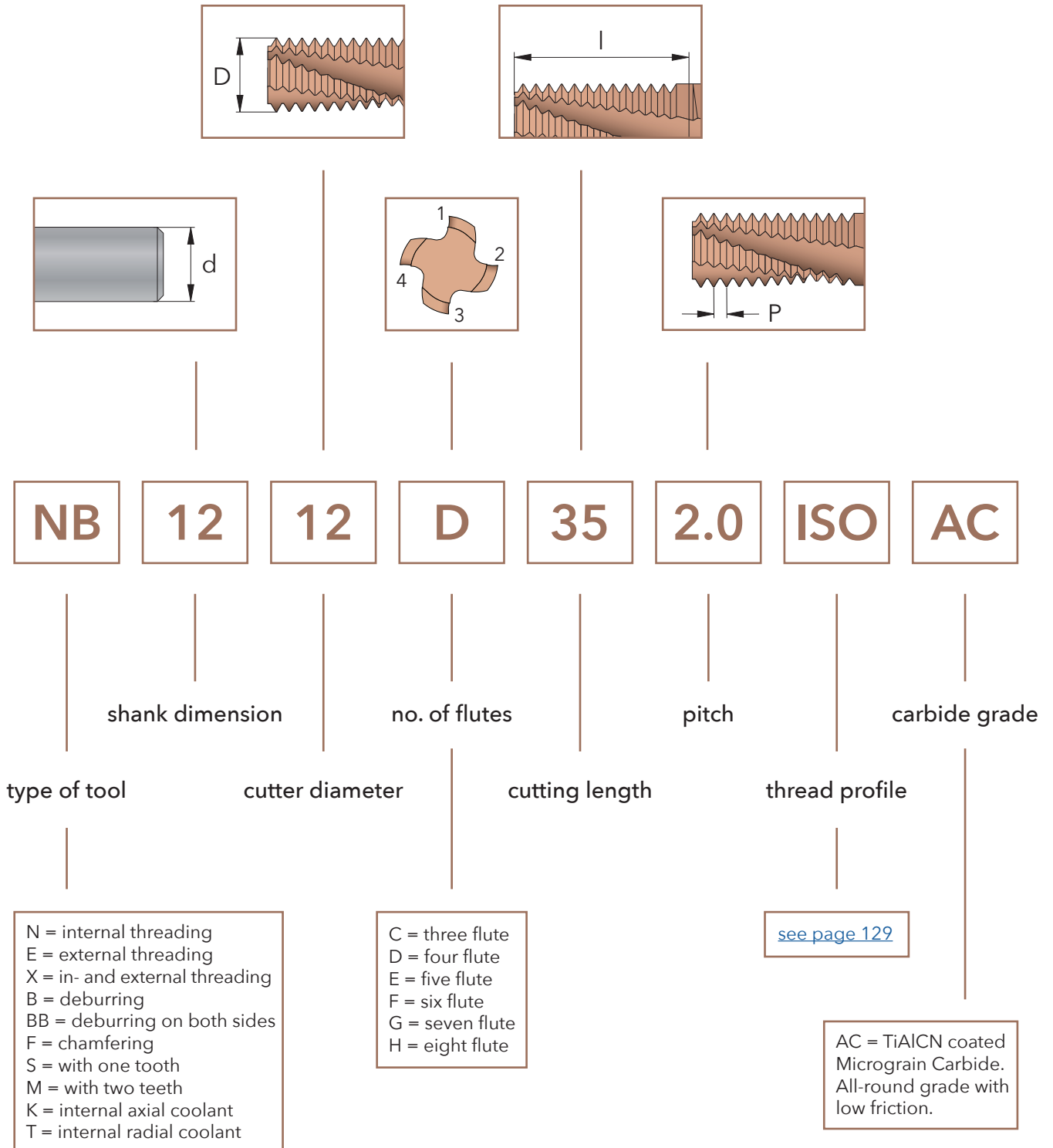

## Cutting Speed ( $V_c$ ) and Material Factor ( $F_m$ )

MATERIAL		Hardness HB	Tensile Strength N/mm <sup>2</sup>	Cutting Speed ( $V_c$ ) m/min	Material Factor ( $F_m$ )
Steel	Low carbon, C < 0,25%	< 120	< 400	150 - 200	1,2
	Medium carbon, C < 0,55%	< 200	< 700	120 - 170	1,1
	High carbon, C < 0,85%	< 250	< 850	110 - 150	1,0
	Low alloy	< 250	< 850	100 - 140	1,0
	High alloy	< 350	< 1200	70 - 110	0,9
	Hardened, HRC < 45			60 - 100	0,8
	Hardened, HRC < 55			30 - 60	0,7
	Hardened, HRC < 65			20 - 40	0,6
Cast iron	Lamellar graphite	< 150	< 500	130 - 180	1,2
	Lamellar graphite	< 300	< 1000	100 - 150	1,1
	Nodular graphite, malleable	< 200	< 700	100 - 150	1,0
	Nodular graphite, malleable	< 300	< 1000	80 - 120	0,9
Stainless steel	Free machining	< 250	< 850	130 - 180	1,0
	Austenitic	< 250	< 850	90 - 140	0,9
	Ferritic and austenitic	< 300	< 1000	80 - 120	0,8
Titanium	Unalloyed	< 200	< 700	60 - 80	0,8
	Alloyed	< 270	< 900	50 - 70	0,7
	Alloyed	< 350	< 1250	30 - 50	0,6
Nickel	Unalloyed	< 150	< 500	80 - 120	0,8
	Alloyed	< 270	< 900	60 - 80	0,7
	Alloyed	< 350	< 1250	50 - 70	0,6
Copper	Unalloyed	< 100	< 350	150 - 250	1,0
	Brass, bronze	< 200	< 700	130 - 180	1,0
	High strength bronze	< 470	< 1500	60 - 80	0,8
Aluminium	Unalloyed	< 100	< 350	500 - 900	1,4
	Alloyed, Si < 0.5%	< 150	< 500	400 - 800	1,3
	Alloyed, Si < 10%	< 120	< 400	300 - 500	1,2
	Alloyed, Si > 10%	< 120	< 400	200 - 400	1,1
Inconel	718	< 370		50 - 70	0,6
Graphite				300 - 500	1,0

## Engagement Factor ( $F_e$ )

	B/d = 0,05	B/d = 0,06	B/d = 0,07	B/d = 0,08	B/d = 0,09	B/d = 0,10	B/d = 0,12	B/d = 0,14	B/d = 0,16
L / d = 1,0	1,75	1,59	1,45	1,31	1,20	1,09	0,99	0,90	0,82
L / d = 1,25	1,52	1,38	1,25	1,14	1,04	0,94	0,86	0,78	0,70
L / d = 1,5	1,31	1,20	1,09	0,99	0,90	0,82	0,74	0,67	0,61
L / d = 1,75	1,20	1,09	0,99	0,90	0,82	0,74	0,67	0,61	0,56
L / d = 2,0	1,09	0,99	0,90	0,82	0,74	0,67	0,61	0,56	0,51
L / d = 2,25	0,99	0,90	0,82	0,74	0,67	0,61	0,56	0,51	0,46
L / d = 2,5	0,90	0,82	0,74	0,67	0,61	0,56	0,51	0,46	0,42
L / d = 3,0	0,78	0,70	0,64	0,58	0,53	0,48	0,44	0,40	0,36
L / d = 3,5	0,67	0,61	0,56	0,51	0,46	0,42	0,38	0,35	0,31
L / d = 4,0	0,61	0,56	0,51	0,46	0,42	0,38	0,35	0,31	0,29

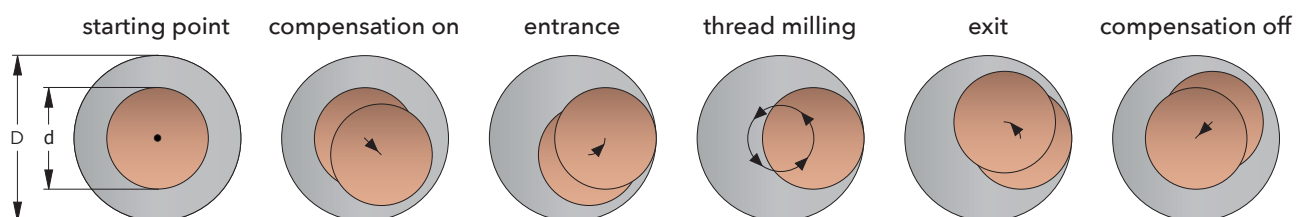

### Diameter Factor ( $F_d$ )

d	Diameter Factor ( $F_d$ )
1,5	0,010
2,0	0,011
3,0	0,015
4,0	0,019
5,0	0,024
6,0	0,028
8,0	0,036
10,0	0,044
12,0	0,052
14,0	0,060
16,0	0,067
18,0	0,075
20,0	0,082
25,0	0,101
32,0	0,126
40,0	0,156

### Example

M24x3,0 thread length 36 mm  
 Carbon Steel, up to 400 N/mm<sup>2</sup>  
 Thread Milling with NB1616C40\_3.0ISO\_AC  
 $B = 0,54 \times 3 = 1,62$  mm  
 $B/d = 1,62/16 = 0,10$   
 $L/d = 36/16 = 2,25$   
 $F_z = 1,2 \times 0,61 \times 0,067 = 0,049$   
 $n = (160 \times 1000) / (\pi \times 16) = 3183$  rpm  
 $V_{fD} = 0,049 \times 3 \times 3183 = 468$  mm/min  
 $V_{fd} = 468 \times (24-16) / 24 = 156$  mm/min  
 $T = (278 \times 24) / 468 = 14$  seconds

$$B = 0,54 \times P$$

$$F_z = F_m \times F_e \times F_d$$

$$n = \frac{V_c \times 1000}{\pi \times d}$$

$$V_{fD} = F_z \times z \times n$$

$$V_{fd} = V_{fD} \times \frac{(D - d)}{D}$$

$$T = 278 \times \frac{D}{V_{fd}}$$

- D = thread diameter (mm)
- L = thread length (mm)
- d = cutter diameter (mm)
- B = depth of profile (mm)
- P = pitch (mm)
- z = no. of flutes
- $F_z$  = feed / flute (mm/flute)
- n = spindle speed (rpm)
- $V_c$  = cutting speed (m/min)
- $V_{fD}$  = feed at thread diameter  $\varnothing$  (mm/min)
- $V_{fd}$  = feed at center of mill (mm/min)
- T = time to mill the thread (seconds)

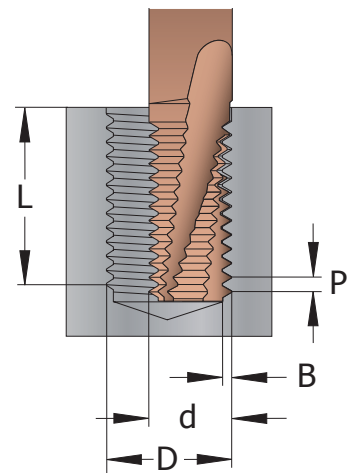

### Carbide Grades

**AC** Micrograin Carbide with TiAlCN coating. All-round grade with low friction. Use cutting data according to the tables.

**FC** Micrograin Carbide with TiAlN coating. All-round grade with high heat resistance. Use cutting data according to the tables.

## ThreadBurr for Internal Threading

**AC**  
TiAlCN coated, Micrograin Carbide

**Tolerance**  
The theoretical external diameter of the cutter is lasermarked on the tool.

**Shank**  
Cylindrical h6, DIN6535 HA

**Flute**  
Between 12° and 18°

**Field of application**  
Thread Milling of all types of steel

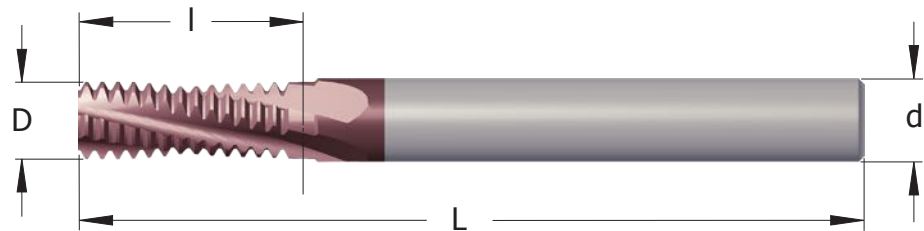

### M

### METRIC

Pitch mm	M coarse	M fine	Vib. free	INTERNAL Part Number	d mm	D mm	Z flutes	l mm	L mm
0,4	M2 (1,5xD)			NB04015C3_0.4ISO_AC	4	1,5	3	3,4	50
0,4	M2 (2xD)			NB04015C4_0.4ISO_AC	4	1,5	3	4,6	50
0,45	M2,2 (1,5xD)			NB04016C3_0.45ISO_AC	4	1,65	3	3,82	50
0,45	M2,2 (2xD)		VF	NB04016C5_0.45ISO_AC	4	1,65	3	5,17	50
0,45	M2,5 (1,5xD)			NB04019C4_0.45ISO_AC	4	1,9	3	4,27	50
0,45	M2,5 (2xD)			NB04019C5_0.45ISO_AC	4	1,9	3	5,62	50
0,5	M3 (1,5xD)	≥ M3,5		NB04023C5_0.5ISO_AC	4	2,3	3	5,25	50
0,5	M3 (1,5xD)	≥ M3,5	VF	NB04023E5_0.5ISO_AC	4	2,3	5	5,25	50
0,5	M3 (2xD)	≥ M3,5		NB04023C6_0.5ISO_AC	4	2,3	3	6,75	50
0,5	M3 (2xD)	≥ M3,5	VF	NB04023D6_0.5ISO_AC	4	2,3	4	6,75	50
0,5	M3 (2,5xD)	≥ M3,5	VF	NB04023C8_0.5ISO_AC	4	2,3	3	8,25	50
0,5	M3 (1,5xD)	≥ M3,5		NB06023C5_0.5ISO_AC	6	2,3	3	5,25	63
0,5	M3 (2xD)	≥ M3,5		NB06023C6_0.5ISO_AC	6	2,3	3	6,75	63
0,5	M3 (2,5xD)	≥ M3,5	VF	NB06023C8_0.5ISO_AC	6	2,3	3	8,25	63
0,5		≥ M5		NB04038C10_0.5ISO_AC	4	3,8	3	10,75	50
0,5		≥ M5		NB06038C10_0.5ISO_AC	6	3,8	3	10,75	63
0,6	M3,5 (1,5xD)			NB04026C6_0.6ISO_AC	4	2,6	3	6,3	50
0,6	M3,5 (2xD)			NB04026C8_0.6ISO_AC	4	2,6	3	8,1	50
0,7	M4 (1,5xD)			NB0403C7_0.7ISO_AC	4	3	3	7,35	50
0,7	M4 (1,5xD)		VF	NB0403E7_0.7ISO_AC	4	3	5	7,35	50
0,7	M4 (2xD)			NB0403C8_0.7ISO_AC	4	3	3	8,75	50
0,7	M4 (2xD)		VF	NB0403D8_0.7ISO_AC	4	3	4	8,75	50
0,7	M4 (2,5xD)		VF	NB0403C10_0.7ISO_AC	4	3	3	10,85	50
0,7	M4 (1,5xD)			NB0603C7_0.7ISO_AC	6	3	3	7,35	63
0,7	M4 (2xD)			NB0603C8_0.7ISO_AC	6	3	3	8,75	63
0,7	M4 (2,5xD)		VF	NB0603C10_0.7ISO_AC	6	3	3	10,85	63
0,75	M4,5 (1,5xD)	≥ M5		NB04034C7_0.75ISO_AC	4	3,4	3	7,87	50
0,75	M4,5 (2xD)	≥ M5		NB04034C10_0.75ISO_AC	4	3,4	3	10,12	50
0,75		≥ M6		NB06045C10_0.75ISO_AC	6	4,5	3	10,87	63
0,75		≥ M6	VF	NB06045C16_0.75ISO_AC	6	4,5	3	16,87	63
0,75		≥ M6	VF	NB06048E10_0.75ISO_AC	6	4,8	5	10,87	63
0,8	M5 (1,5xD)			NB04038C8_0.8ISO_AC	4	3,8	3	8,4	50
0,8	M5 (1,5xD)		VF	NB04038E8_0.8ISO_AC	4	3,8	5	8,4	50
0,8	M5 (2xD)			NB04038C10_0.8ISO_AC	4	3,8	3	10,8	50
0,8	M5 (2xD)		VF	NB04038D10_0.8ISO_AC	4	3,8	4	10,8	50
0,8	M5 (2,5xD)		VF	NB04038C13_0.8ISO_AC	4	3,8	3	13,2	50
0,8	M5 (1,5xD)			NB06038C8_0.8ISO_AC	6	3,8	3	8,4	63
0,8	M5 (2xD)			NB06038C10_0.8ISO_AC	6	3,8	3	10,8	63
0,8	M5 (2,5xD)			NB06038C13_0.8ISO_AC	6	3,8	3	13,2	63
1	M6 (1,5xD)	≥ M8		NB06045C10_1.0ISO_AC	6	4,5	3	10,5	63
1	M6 (1,5xD)	≥ M8	VF	NB06045E10_1.0ISO_AC	6	4,5	5	10,5	63
1	M6 (2xD)	≥ M8		NB06045C13_1.0ISO_AC	6	4,5	3	13,5	63
1	M6 (2xD)	≥ M8	VF	NB06045D13_1.0ISO_AC	6	4,5	4	13,5	63
1	M6 (2,5xD)	≥ M8	VF	NB06045C16_1.0ISO_AC	6	4,5	3	16,5	63
1	M6 (3xD)	≥ M8	VF	NB06045C19_1.0ISO_AC	6	4,5	3	19,5	63
1		≥ M8		NB0606C10_1.0ISO_AC	6	6	3	10,5	63
1		≥ M8		NB0606C13_1.0ISO_AC	6	6	3	13,5	63
1		≥ M8	VF	NB0606E14_1.0ISO_AC	6	6	5	14,5	63

VF = Vibration-Free if you use the entire cutting length, [see page 6](#).



continue

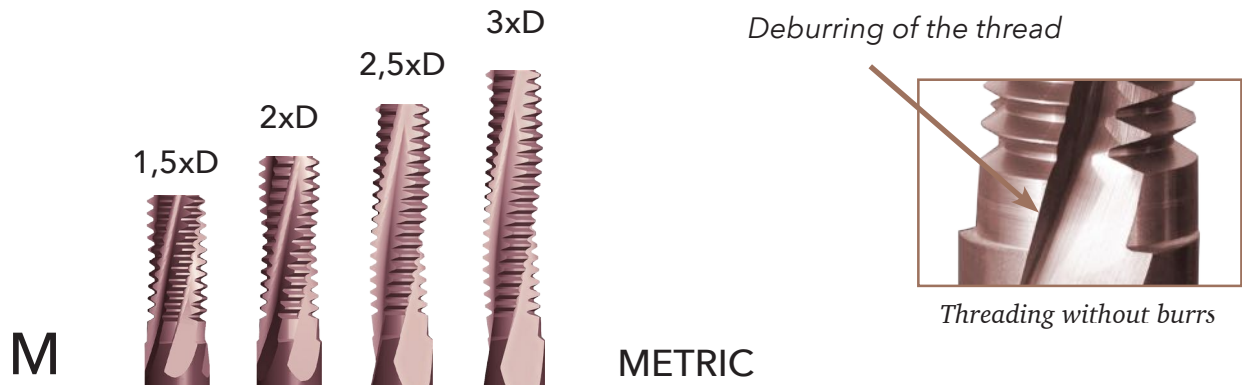

Pitch mm	M coarse	M fine	Vib. free	INTERNAL Part Number	d mm	D mm	Z flutes	l mm	L mm
1		≥ M10		NB0808D10_1.0ISO_AC	8	8	4	10,5	63
1		≥ M10		NB0808D13_1.0ISO_AC	8	8	4	13,5	63
1		≥ M10	VF	NB0808F16_1.0ISO_AC	8	8	6	16,5	63
1		≥ M10		NB0808D17_1.0ISO_AC	8	8	4	17,5	63
1		≥ M12		NB1010E14_1.0ISO_AC	10	10	5	14,5	76
1		≥ M12	VF	NB1010G17_1.0ISO_AC	10	10	7	17,5	76
1		≥ M12	VF	NB1010E19_1.0ISO_AC	10	10	5	19,5	76
1		≥ M14		NB1212F15_1.0ISO_AC	12	12	6	15,5	83
1		≥ M14	VF	NB1212H18_1.0ISO_AC	12	12	8	18,5	83
1		≥ M14	VF	NB1212F21_1.0ISO_AC	12	12	6	21,5	83
1,25	M8 (1,5xD)	≥ M10		NB0606C14_1.25ISO_AC	6	6	3	14,37	63
1,25	M8 (1,5xD)	≥ M10	VF	NB0606E14_1.25ISO_AC	6	6	5	14,37	63
1,25	M8 (2xD)	≥ M10		NB0606C18_1.25ISO_AC	6	6	3	18,12	63
1,25	M8 (2xD)	≥ M10	VF	NB0606D18_1.25ISO_AC	6	6	4	18,12	63
1,25	M8 (2,5xD)	≥ M10	VF	NB0606C21_1.25ISO_AC	6	6	3	21,87	63
1,25	M8 (3xD)	≥ M10	VF	NB0606C25_1.25ISO_AC	6	6	3	25,62	76
1,5	M10 (1,5xD)	≥ M12		NB08075C17_1.5ISO_AC	8	7,5	3	17,25	63
1,5	M10 (1,5xD)	≥ M12	VF	NB08075E17_1.5ISO_AC	8	7,5	5	17,25	63
1,5	M10 (2xD)	≥ M12		NB08075C21_1.5ISO_AC	8	7,5	3	21,75	76
1,5	M10 (2xD)	≥ M12	VF	NB08075D21_1.5ISO_AC	8	7,5	4	21,75	76
1,5	M10 (2,5xD)	≥ M12	VF	NB08075C27_1.5ISO_AC	8	7,5	3	27,75	76
1,5	M10 (3xD)	≥ M12	VF	NB08075C32_1.5ISO_AC	8	7,5	3	32,25	76
1,5		≥ M14		NB1010D17_1.5ISO_AC	10	10	4	17,25	76
1,5		≥ M14	VF	NB1010F20_1.5ISO_AC	10	10	6	20,25	76
1,5		≥ M14		NB1010D23_1.5ISO_AC	10	10	4	23,25	76
1,5		≥ M16		NB1212E15_1.5ISO_AC	12	12	5	15,75	83
1,5		≥ M16		NB1212E21_1.5ISO_AC	12	12	5	21,75	83
1,5		≥ M16	VF	NB1212G21_1.5ISO_AC	12	12	7	21,75	83
1,5		≥ M16	VF	NB1212E29_1.5ISO_AC	12	12	5	29,25	83
1,5		≥ M20		NB1616F18_1.5ISO_AC	16	16	6	18,75	89
1,5		≥ M20	VF	NB1616H24_1.5ISO_AC	16	16	8	24,75	89
1,5		≥ M20	VF	NB1616F26_1.5ISO_AC	16	16	6	26,25	89
1,5		≥ M20	VF	NB1616F35_1.5ISO_AC	16	16	6	35,25	100
1,75	M12 (1,5xD)			NB0808C20_1.75ISO_AC	8	8	3	20,12	76
1,75	M12 (2xD)		VF	NB0808C27_1.75ISO_AC	8	8	3	27,12	76
1,75	M12 (1,5xD)			NB1009C20_1.75ISO_AC	10	9	3	20,12	76
1,75	M12 (1,5xD)		VF	NB1009E20_1.75ISO_AC	10	9	5	20,12	76
1,75	M12 (2xD)			NB1009C27_1.75ISO_AC	10	9	3	27,12	76
1,75	M12 (2xD)		VF	NB1009D27_1.75ISO_AC	10	9	4	27,12	76
1,75	M12 (2,5xD)		VF	NB1009C32_1.75ISO_AC	10	9	3	32,37	100
1,75	M12 (3xD)		VF	NB1009C37_1.75ISO_AC	10	9	3	37,62	100
2	M14 (1,5xD)	≥ M18		NB1010C23_2.0ISO_AC	10	10	3	23	76
2	M14 (2xD)	≥ M18		NB1010C31_2.0ISO_AC	10	10	3	31	100
2	M14 (2,5xD)	≥ M18	VF	NB1010C37_2.0ISO_AC	10	10	3	37	100
2	M16 (1,5xD)	≥ M18		NB1212D27_2.0ISO_AC	12	12	4	27	83
2	M16 (1,5xD)	≥ M18	VF	NB1212E27_2.0ISO_AC	12	12	5	27	83
2	M16 (2xD)	≥ M18	VF	NB1212D35_2.0ISO_AC	12	12	4	35	100
2	M16 (2,5xD)	≥ M18	VF	NB1212D43_2.0ISO_AC	12	12	4	43	100
2	M16 (3xD)	≥ M18	VF	NB1212C51_2.0ISO_AC	12	12	3	51	100

## M METRIC

Pitch mm	M coarse	M fine	Vib. free	INTERNAL Part Number	d mm	D mm	Z flutes	l mm	L mm
2		≥ M20		NB1616E29_2.0ISO_AC	16	16	5	29	89
2		≥ M20	VF	NB1616E39_2.0ISO_AC	16	16	5	39	100
2		≥ M24	VF	NB2020F43_2.0ISO_AC	20	20	6	43	100
2		≥ M24		NB2020F57_2.0ISO_AC	20	20	6	57	120
2,5	M18 (1,5xD)			NB1212C31_2.5ISO_AC	12	12	3	31,25	100
2,5	M18 (2xD)		VF	NB1212C38_2.5ISO_AC	12	12	3	38,75	100
2,5	M18 (2,5xD)		VF	NB1212C48_2.5ISO_AC	12	12	3	48,75	100
2,5	M20 (1,5xD)			NB1414D33_2.5ISO_AC	14	14	4	33,75	89
2,5	M20 (1,5xD)		VF	NB1414E33_2.5ISO_AC	14	14	5	33,75	89
2,5	M20 (2xD)		VF	NB1414D43_2.5ISO_AC	14	14	4	43,75	100
2,5	M20 (2,5xD)		VF	NB1615D53_2.5ISO_AC	16	15	4	53,75	120
2,5	M20 (3xD)		VF	NB1615C63_2.5ISO_AC	16	15	3	63,75	120
3	M24 (1,5xD)	≥ M30		NB1616C40_3.0ISO_AC	16	16	3	40,5	100
3	M24 (2xD)	≥ M30	VF	NB1616C52_3.0ISO_AC	16	16	3	52,5	120
3	M24 (2,5xD)	≥ M30	VF	NB1818C64_3.0ISO_AC	18	18	3	64,5	130
3		≥ M30		NB2020D46_3.0ISO_AC	20	20	4	46,5	120
3		≥ M30	VF	NB2020D61_3.0ISO_AC	20	20	4	61,5	150
3,5	M30 (1,5xD)			NB2020C50_3.5ISO_AC	20	20	3	50,75	120
3,5	M30 (2xD)		VF	NB2020C64_3.5ISO_AC	20	20	3	64,75	150
3,5	M30 (2,5xD)		VF	NB2020C78_3.5ISO_AC	20	20	3	78,75	150
4	M36 (1,5xD)	≥ M42		NB2020C58_4.0ISO_AC	20	20	3	58	150

## ThreadBurr for External Threading

## M METRIC

Pitch mm	Vib. free	EXTERNAL Part Number	d mm	D mm	Z flutes	l mm	L mm
1,0	VF	EB1010E21_1.0ISO_AC	10	10	5	21,5	76
1,5	VF	EB1212E26_1.5ISO_AC	12	12	5	26,25	83
2,0	VF	EB1616E35_2.0ISO_AC	16	16	5	35	100

### Is it possible to use internal thread mills for external threads?

You can not use internal thread mills for external threads when threading Metrical (M) and Unified (UN) threads. They have different profile for internal and external. The internal thread has a bigger crest than root and for the external thread it is the opposite, the root is bigger than the crest.

Profiles such as W, BSPT, PG, NPT, NPTF and NPSF has the same crest as root and because of this it is possible for these profiles to use the same thread mill for internal and external threads.

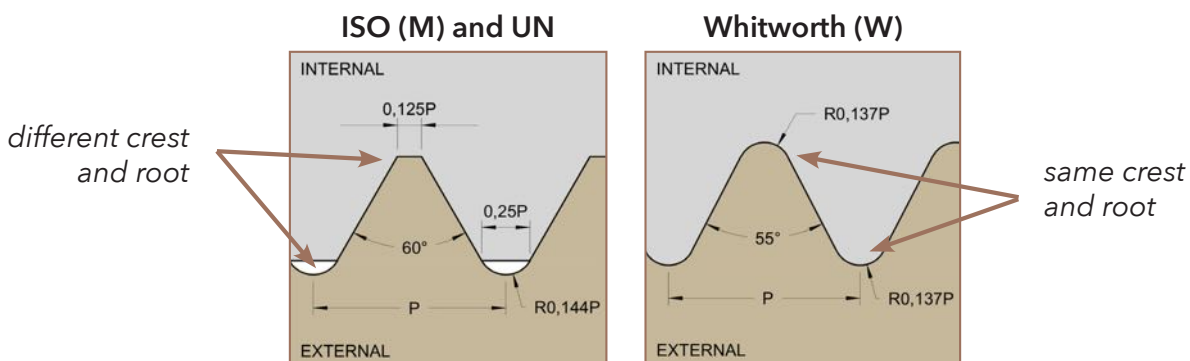

## ThreadBurr

## AC

TiAlCN coated, Micrograin Carbide

## Tolerance

The theoretical external diameter of the cutter is laser marked on the tool.

## Shank

Cylindrical h6, DIN6535 HA

## Flute

Between 12° and 18°

## Field of application

Thread Milling of all types of steel

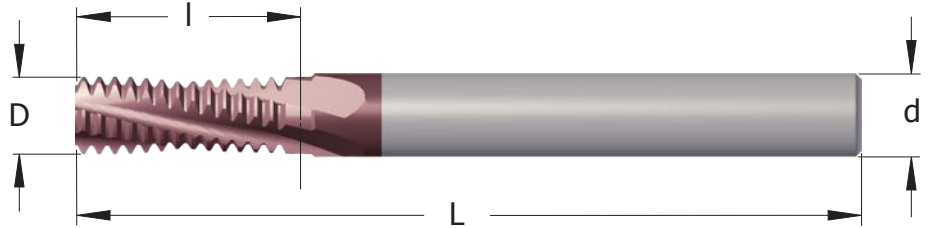

## G/Rp

## WHITWORTH PIPE THREAD

Pitch TPI	Standard	Vib. free	INTERNAL / EXTERNAL Part Number	d mm	D mm	Z flutes	l mm	L mm
28	G 1/16 - 1/8		XB0606C10_28W_AC	6	6	3	10,43	63
28	G 1/16 - 1/8	VF	XB0606F10_28W_AC	6	6	6	10,43	63
28	G 1/8		XB0808D14_28W_AC	8	8	4	14,06	63
28	G 1/8	VF	XB0808G14_28W_AC	8	8	7	14,06	63
19	G 1/4 - 3/8		XB0808C15_19W_AC	8	8	3	15,37	63
19	G 1/4 - 3/8	VF	XB0808F15_19W_AC	8	8	6	15,37	63
19	G 1/4 - 3/8		XB1010D22_19W_AC	10	10	4	22,06	76
19	G 1/4 - 3/8	VF	XB1010F22_19W_AC	10	10	6	22,06	76
14	G 1/2 - 7/8		XB1212D20_14W_AC	12	12	4	20,86	83
14	G 1/2 - 7/8	VF	XB1212G20_14W_AC	12	12	7	20,86	83
14	G 1/2 - 7/8		XB1212D28_14W_AC	12	12	4	28,12	83
14	G 1/2 - 7/8		XB1616E28_14W_AC	16	16	5	28,12	89
14	G 1/2 - 7/8	VF	XB1616G28_14W_AC	16	16	7	28,12	89
11	G 1 - 1 1/2		XB1212C26_11W_AC	12	12	3	26,55	83
11	G 1 - 1 1/2	VF	XB1212E26_11W_AC	12	12	5	26,55	83
11	G 1 - 3	VF	XB1616D40_11W_AC	16	16	4	40,41	100
11	G ≥ 1	VF	XB2020E49_11W_AC	20	20	5	49,65	120

## R/Rc

## BSPT PIPE THREAD

Pitch TPI	Standard	Vib. free	INTERNAL / EXTERNAL Part Number	d mm	D mm	Z flutes	l mm	L mm
28	Rc 1/16 - 1/8		XB0606C10_28BSPT_AC	6	6	3	10,43	63
28	Rc 1/8		XB0808D14_28BSPT_AC	8	8	4	14,06	63
19	Rc 1/4 - 3/8		XB0808C15_19BSPT_AC	8	8	3	15,37	63
19	Rc 1/4 - 3/8		XB1010D22_19BSPT_AC	10	10	4	22,06	76
14	Rc 1/2 - 7/8		XB1212D20_14BSPT_AC	12	12	4	20,86	83
11	Rc 1 - 2		XB1616D31_11BSPT_AC	16	16	4	31,17	89

## PG

## STEEL CONDUIT THREAD DIN 40430

Pitch TPI	Standard	Vib. free	INTERNAL / EXTERNAL Part Number	d mm	D mm	Z flutes	l mm	L mm
20	Pg 7		XB0808C21_20PG_AC	8	8	3	20,96	63
18	Pg 9 - 16		XB1010C27_18PG_AC	10	10	3	27,52	76
16	Pg 21 - 48	VF	XB1212D31_16PG_AC	12	12	4	30,96	83

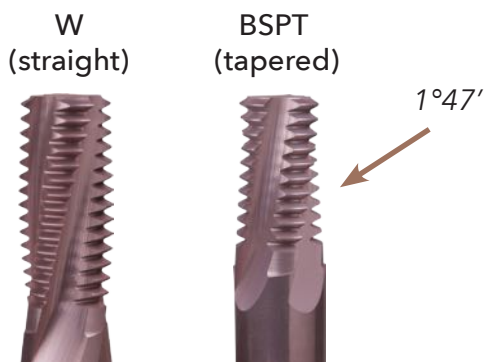
VF = Vibration-Free if you use the entire cutting length, [see page 6](#).

## How to know if I need W or BSPT?

Whitworth is a profile that is mainly used for pipe threads. When it is a straight thread it is W and when it is tapered BSPT.

G thread	→	W
Rp thread	→	W
Rc thread	→	BSPT
R thread	→	BSPT

For more  
information  
[see page 128](#).

## ThreadBurr for Internal Threading

### AC

TiAlCN coated, Micrograin Carbide

### Tolerance

The theoretical external diameter of the cutter is laser marked on the tool.

### Shank

Cylindrical h6, DIN6535 HA

### Flute

Between 12° and 18°

### Field of application

Thread Milling of all types of steel

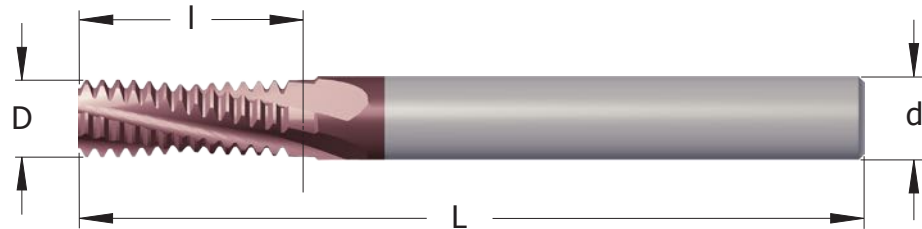

## UN

## UNIFIED

Pitch TPI	UNC	UNF	Vib. free	INTERNAL Part Number	d mm	D mm	Z flutes	l mm	L mm
64		No. 2 (1,5xD)		NB04017C3_64UN_AC	4	1,7	3	3,77	50
64		No. 2 (2xD)		NB04017C5_64UN_AC	4	1,7	3	4,96	50
56	No. 2 (1,5xD)			NB04016C3_56UN_AC	4	1,6	3	3,86	50
56	No. 2 (2xD)		VF	NB04016C5_56UN_AC	4	1,6	3	5,22	50
56		No. 3 (1,5xD)		NB04019C4_56UN_AC	4	1,9	3	4,31	50
56		No. 3 (2xD)		NB04019C5_56UN_AC	4	1,9	3	5,67	50
48	No. 3 (1,5xD)			NB04019C4_48UN_AC	4	1,9	3	4,5	50
48	No. 3 (2xD)			NB04019C5_48UN_AC	4	1,9	3	5,56	50
48		No. 4 (1,5xD)		NB04021C5_48UN_AC	4	2,1	3	5,03	50
48		No. 4 (2xD)		NB04021C6_48UN_AC	4	2,1	3	6,61	50
44		No.5 (1,5xD)		NB04024C5_44UN_AC	4	2,4	3	5,48	50
44		No.5 (2xD)		NB04024C7_44UN_AC	4	2,4	3	7,22	50
40	No. 4 (1,5xD)			NB04021C5_40UN_AC	4	2,1	3	5,4	50
40	No. 4 (2xD)			NB04021C6_40UN_AC	4	2,1	3	6,67	50
40	No.5 (1,5xD)			NB04023C5_40UN_AC	4	2,3	3	5,4	50
40	No.5 (2xD)			NB04023C7_40UN_AC	4	2,3	3	7,3	50
40	No.5 (2,5xD)		VF	NB04023C8_40UN_AC	4	2,3	3	8,57	50
40		No.6 (1,5xD)		NB04026C6_40UN_AC	4	2,6	3	6,03	50
40		No.6 (2xD)		NB04026C8_40UN_AC	4	2,6	3	7,94	50
36		No.8 (1,5xD)		NB04031C7_36UN_AC	4	3,1	3	7,41	50
36		No.8 (2xD)		NB04031C9_36UN_AC	4	3,1	3	9,53	50
32	No.6 (1,5xD)			NB04025C6_32UN_AC	4	2,5	3	6,75	50
32	No.6 (2xD)		VF	NB04025C8_32UN_AC	4	2,5	3	8,33	50
32	No.6 (2,5xD)		VF	NB04025C10_32UN_AC	4	2,5	3	9,92	50
32	No.8 (1,5xD)			NB0403C7_32UN_AC	4	3	3	7,54	50
32	No.8 (2xD)			NB0403C9_32UN_AC	4	3	3	9,13	50
32	No.8 (2,5xD)		VF	NB0403C11_32UN_AC	4	3	3	11,51	50
32		No.10 (1,5xD)		NB04036C8_32UN_AC	4	3,6	3	8,33	50
32		No.10 (2xD)		NB04036C10_32UN_AC	4	3,6	3	10,72	50
32				NB0606D13_32UN_AC	6	6	4	13,1	63
28		No.12 (1,5xD)		NB0404C9_28UN_AC	4	4	3	9,52	50
28		No.12 (2xD)		NB0404C12_28UN_AC	4	4	3	12,25	50
28		1/4 (1,5xD)		NB0605C10_28UN_AC	6	5	3	10,43	63
28		1/4 (2xD)		NB0605C14_28UN_AC	6	5	3	14,06	63
28				NB0808D17_28UN_AC	8	8	4	17,69	63
24	No.10 (1,5xD)			NB04036C9_24UN_AC	4	3,6	3	9	50
24	No.10 (2xD)			NB04036C11_24UN_AC	4	3,6	3	11,11	50
24	No.10 (2,5xD)		VF	NB04036C13_24UN_AC	4	3,6	3	13,23	50
24	No.12 (1,5xD)			NB0404C10_24UN_AC	4	4	3	10,05	50
24	No.12 (2xD)			NB0404C12_24UN_AC	4	4	3	12,17	50
24	No.12 (2,5xD)		VF	NB0404C15_24UN_AC	4	4	3	15,35	50
24		5/16 (1,5xD)		NB0606C13_24UN_AC	6	6	3	13,23	63
24		5/16 (2xD)		NB0606C17_24UN_AC	6	6	3	17,46	63
24		3/8 (1,5xD)		NB08076C15_24UN_AC	8	7,6	3	15,35	63
24		3/8 (2xD)		NB08076C20_24UN_AC	8	7,6	3	20,64	76
20	1/4 (1,5xD)			NB06045C10_20UN_AC	6	4,5	3	10,8	63
20	1/4 (2xD)		VF	NB06045C14_20UN_AC	6	4,5	3	14,6	63
20	1/4 (2,5xD)		VF	NB06045C17_20UN_AC	6	4,5	3	17,15	63

VF = Vibration-Free if you use the entire cutting length, [see page 6](#).

continue

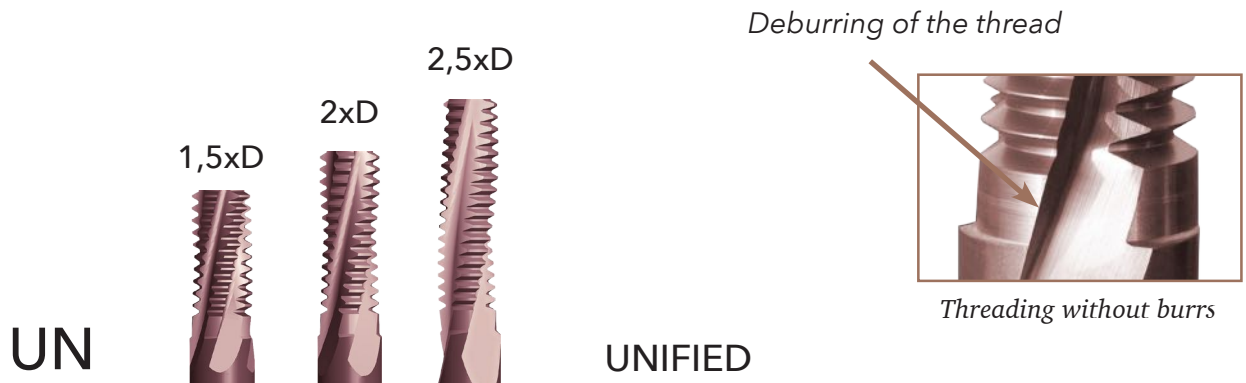

UN

UNIFIED

Pitch TPI	UNC	UNF	Vib. free	INTERNAL Part Number	d mm	D mm	Z flutes	l mm	L mm
20		7/16 (1,5xD)		NB0808C18_20UN_AC	8	8	3	18,41	63
20		7/16 (2xD)		NB0808C23_20UN_AC	8	8	3	23,5	76
20		1/2 (1,5xD)		NB1010D21_20UN_AC	10	10	4	20,96	76
20		1/2 (2xD)	VF	NB1010D27_20UN_AC	10	10	4	27,31	76
20			VF	NB1212E28_20UN_AC	12	12	5	28,57	83
18	5/16 (1,5xD)			NB06058C13_18UN_AC	6	5,8	3	13,41	63
18	5/16 (2xD)			NB06058C17_18UN_AC	6	5,8	3	17,64	63
18	5/16 (2,5xD)		VF	NB06058C21_18UN_AC	6	5,8	3	21,87	63
18		9/16 (1,5xD)		NB1010D23_18UN_AC	10	10	4	23,28	76
18		9/16 (2xD)	VF	NB1010D30_18UN_AC	10	10	4	30,34	100
18		5/8 (1,5xD)		NB1212D26_18UN_AC	12	12	4	26,11	83
18		5/8 (2xD)	VF	NB1212D33_18UN_AC	12	12	4	33,16	100
16	3/8 (1,5xD)			NB0606C16_16UN_AC	6	6	3	16,67	63
16	3/8 (2xD)		VF	NB0606C21_16UN_AC	6	6	3	21,43	63
16	3/8 (2,5xD)		VF	NB0807C26_16UN_AC	8	7	3	26,19	76
16		3/4 (1,5xD)	VF	NB1212D31_16UN_AC	12	12	4	30,96	100
16		3/4 (2xD)	VF	NB1212D40_16UN_AC	12	12	4	40,48	100
16			VF	NB1616E35_16UN_AC	16	16	5	35,72	100
14	7/16 (1,5xD)			NB0808C19_14UN_AC	8	8	3	19,05	63
14	7/16 (2xD)			NB0808C24_14UN_AC	8	8	3	24,49	76
14	7/16 (2,5xD)		VF	NB0808C30_14UN_AC	8	8	3	29,94	76
14		7/8 (1,5xD)	VF	NB1616E35_14UN_AC	16	16	5	35,38	100
14		7/8 (2xD)	VF	NB1616E46_14UN_AC	16	16	5	46,26	120
13	1/2 (1,5xD)			NB0808C22_13UN_AC	8	8	3	22,47	76
13	1/2 (2xD)		VF	NB0808C28_13UN_AC	8	8	3	28,33	76
13	1/2 (2,5xD)		VF	NB10093C34_13UN_AC	10	9,3	3	34,19	100
12	9/16 (1,5xD)			NB1010C24_12UN_AC	10	10	3	24,34	76
12	9/16 (2xD)			NB1010C30_12UN_AC	10	10	3	30,69	100
12			VF	NB1616E43_12UN_AC	16	16	5	43,39	100
11	5/8 (1,5xD)			NB1010C26_11UN_AC	10	10	3	26,55	76
11	5/8 (2xD)		VF	NB1010C35_11UN_AC	10	10	3	35,79	100
11	5/8 (2,5xD)		VF	NB12117C42_11UN_AC	12	11,7	3	42,72	100
10	3/4 (1,5xD)			NB1212C31_10UN_AC	12	12	3	31,75	100
10	3/4 (2xD)		VF	NB1212C41_10UN_AC	12	12	3	41,91	100
9	7/8 (1,5xD)			NB1616C38_9UN_AC	16	16	3	38,1	100
9	7/8 (2xD)			NB1616C49_9UN_AC	16	16	3	49,39	120
8	1 (1,5xD)			NB1616C42_8UN_AC	16	16	3	42,86	100
8	1 (2xD)		VF	NB1616C55_8UN_AC	16	16	3	55,56	120
8			VF	NB2020D49_8UN_AC	20	20	4	49,21	120
7	1 1/8 - 1 1/4 (1,5xD)			NB2020C52_7UN_AC	20	20	3	52,61	120
6	1 3/8 - 1 1/2 (1,5xD)			NB2525C61_6UN_AC	25	25	3	61,38	130



## ThreadBurr

**AC**  
TiAlCN coated, Micrograin Carbide  
**Tolerance**  
D 6,0 - 12,0 +0 / -0,030  
D 16,0 - 20,0 +0 / -0,050  
**Shank**  
Cylindrical h6, DIN6535 HA  
**Flute**  
Between 12° and 18°  
**Field of application**  
Thread Milling of all types of steel

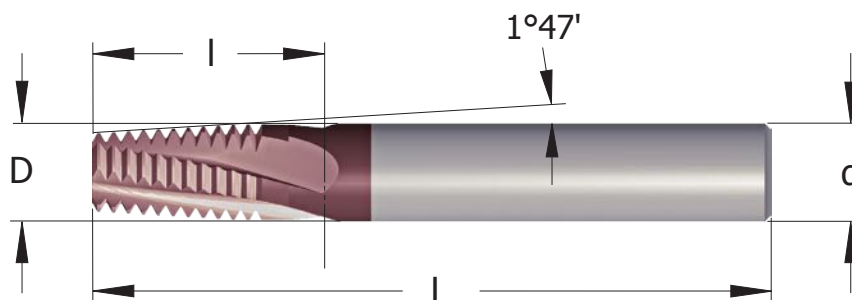

## NPT

### NPT PIPE THREAD

Pitch TPI	Standard	Vib. free	INTERNAL / EXTERNAL Part Number	d mm	D mm	Z flutes	l mm	L mm
27	1/16 - 1/8		XB0606C10_27NPT_AC	6	6	3	10,82	63
27	1/16 - 1/8	VF	XB0606F10_27NPT_AC	6	6	6	10,82	63
18	1/4 - 3/8		XB0808C16_18NPT_AC	8	8	3	16,23	63
18	1/4 - 3/8	VF	XB0808F16_18NPT_AC	8	8	6	16,23	63
18	1/4 - 3/8		XB1010D16_18NPT_AC	10	10	4	16,23	76
14	1/2 - 3/4		XB1212D22_14NPT_AC	12	12	4	22,68	83
14	1/2 - 3/4	VF	XB1212F22_14NPT_AC	12	12	6	22,68	83
14	3/4		XB1616E22_14NPT_AC	16	16	5	22,68	89
11,5	1 - 2		XB1616D29_11.5NPT_AC	16	16	4	29,82	89
11,5	1 - 2	VF	XB1616F29_11.5NPT_AC	16	16	6	29,82	89
8	≥ 2 1/2		XB2020D42_8NPT_AC	20	20	4	42,86	100

## NPTF

### NPTF DRYSEAL PIPE THREAD

Pitch TPI	Standard	Vib. free	INTERNAL / EXTERNAL Part Number	d mm	D mm	Z flutes	l mm	L mm
27	1/16 - 1/8		XB0606C10_27NPTF_AC	6	6	3	10,82	63
18	1/4 - 3/8		XB0808C16_18NPTF_AC	8	8	3	16,23	63
14	1/2 - 3/4		XB1212D22_14NPTF_AC	12	12	4	22,68	83
11,5	1 - 2		XB1616D29_11.5NPTF_AC	16	16	4	29,82	89
8	≥ 2 1/2		XB2020D42_8NPTF_AC	20	20	4	42,86	100

## NPSF

### NPSF PIPE THREAD

Pitch TPI	Standard	Vib. free	INTERNAL / EXTERNAL Part Number	d mm	D mm	Z flutes	l mm	L mm
27	1/16 - 1/8		XB0606C12_27NPSF_AC	6	6	3	12,70	63
18	1/4 - 3/8		XB0808C16_18NPSF_AC	8	8	3	16,23	63
14	1/2 - 3/4		XB1212D22_14NPSF_AC	12	12	4	22,68	83
11,5	1		XB1616D29_11.5NPSF_AC	16	16	4	29,82	89

VF = Vibration-Free if you use the entire cutting length, [see page 6](#).

## What is the difference between NPT, NPTF and NPSF?

NPT and NPTF are tapered threads. NPSF is a straight thread. Leakage can occur on NPT threads which means that a thread seal tape or other thread sealant has to be used to get a leak-free thread.

To solve the problem of leakage, NPTF has been developed. This thread create full contact between the external and internal thread and will make a press fit. No other product for sealing is needed.

Another variation of dryseal is NPSF which is used for internal threads and is made to fit an external NPTF thread.

**FC**  
TiAlN coated, Micrograin Carbide  
**Tolerance**  
D 5,0 - 17,0 +0 / -0,050  
**Shank**  
Cylindrical h6, DIN6535 HA  
**Flute**  
30° right hand spiral  
**Field of application**  
Before Thread Milling of  
NPT/NPTF/BSPT

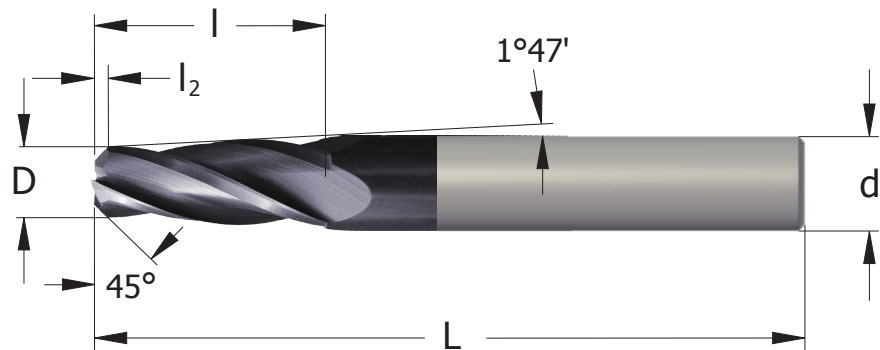

D mm	d mm	Part Number	Z flutes	l mm	l <sub>2</sub> mm	L mm
5	6	NPT0605D16_FC	4	16	1,0	63
8,5	10	NPT10085D24_FC	4	24	1,5	76
14	16	NPT1614D32_FC	4	32	2	89
17	20	NPT2017D48_FC	4	48	3	120

## Do I need to premill a tapered hole before threading?

It is not necessary, but we strongly recommend it as there are two major advantages of premilling a tapered hole before threading.

1. Longer tool life of the thread mill.
2. Shorter machining time.

Without premilling you have to make the thread in one or two extra passes and reduce the feed, otherwise you will destroy the tool as the crest is very small on NPT and NPTF threads.

*Chamfering of the thread*

*Premilling of conical holes  
result in longer tool life and  
shorter machining time*



## ThreadBurr with Internal Axial Coolant

**AC**

TiAlCN coated, Micrograin Carbide

**Tolerance**

The theoretical external diameter of the cutter is laser marked on the tool.

**Shank**

Cylindrical h6, DIN6535 HA

**Flute**

Between 12° and 18°

**Field of application**

Thread Milling of all types of steel

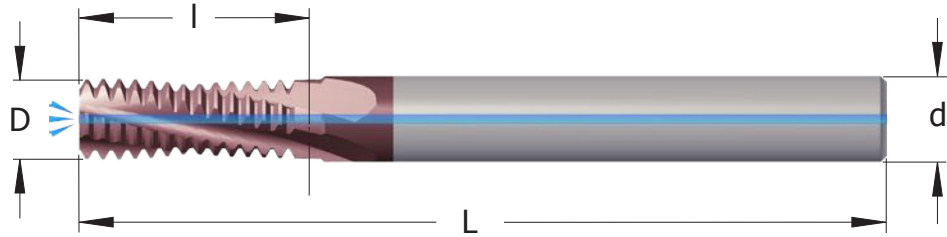

### M

### METRIC

Pitch mm	M coarse	M fine	Vib. free	INTERNAL Part Number	d mm	D mm	Z flutes	l mm	L mm
0,8	M5 (1,5xD)			NBK04038C8_0.8ISO_AC	4	3,8	3	8,4	50
0,8	M5 (2xD)			NBK04038C10_0.8ISO_AC	4	3,8	3	10,8	50
0,8	M5 (2,5xD)		VF	NBK04038C13_0.8ISO_AC	4	3,8	3	13,2	50
1,0	M6 (1,5xD)	≥ M8		NBK06045C10_1.0ISO_AC	6	4,5	3	10,5	63
1,0	M6 (2xD)	≥ M8		NBK06045C13_1.0ISO_AC	6	4,5	3	13,5	63
1,0	M6 (2,5xD)	≥ M8	VF	NBK06045C16_1.0ISO_AC	6	4,5	3	16,5	63
1,0		≥ M10		NBK0808D17_1.0ISO_AC	8	8	4	17,5	76
1,25	M8 (1,5xD)	≥ M10		NBK0606C14_1.25ISO_AC	6	6	3	14,37	63
1,25	M8 (2xD)	≥ M10		NBK0606C18_1.25ISO_AC	6	6	3	18,12	63
1,25	M8 (2,5xD)	≥ M10	VF	NBK0606C21_1.25ISO_AC	6	6	3	21,87	63
1,5	M10 (1,5xD)	≥ M12		NBK08075C17_1.5ISO_AC	8	7,5	3	17,25	76
1,5	M10 (2xD)	≥ M12		NBK08075C21_1.5ISO_AC	8	7,5	3	21,75	76
1,5	M10 (2,5xD)	≥ M12	VF	NBK08075C27_1.5ISO_AC	8	7,5	3	27,75	76
1,5	M10 (3xD)	≥ M12	VF	NBK08075C32_1.5ISO_AC	8	7,5	3	32,25	76
1,5		≥ M16	VF	NBK1212E29_1.5ISO_AC	12	12	5	29,25	100
1,5		≥ M20	VF	NBK1616F35_1.5ISO_AC	16	16	6	35,25	120
1,75	M12 (1,5xD)			NBK0808C20_1.75ISO_AC	8	8	3	20,12	76
1,75	M12 (2xD)		VF	NBK0808C27_1.75ISO_AC	8	8	3	27,12	76
1,75	M12 (1,5xD)			NBK1009C20_1.75ISO_AC	10	9	3	20,12	100
1,75	M12 (2xD)			NBK1009C27_1.75ISO_AC	10	9	3	27,12	100
1,75	M12 (2,5xD)		VF	NBK1009C32_1.75ISO_AC	10	9	3	32,37	100
1,75	M12 (3xD)		VF	NBK1009C37_1.75ISO_AC	10	9	3	37,62	100
2,0	M14 (1,5xD)	≥ M18		NBK1010C23_2.0ISO_AC	10	10	3	23	100
2,0	M14 (2xD)	≥ M18		NBK1010C31_2.0ISO_AC	10	10	3	31	100
2,0	M16 (1,5xD)	≥ M18		NBK1212D27_2.0ISO_AC	12	12	4	27	100
2,0	M16 (2xD)	≥ M18	VF	NBK1212D35_2.0ISO_AC	12	12	4	35	100
2,0	M16 (2,5xD)	≥ M18	VF	NBK1212D43_2.0ISO_AC	12	12	4	43	100
2,0	M16 (3xD)	≥ M18	VF	NBK1212C51_2.0ISO_AC	12	12	3	51	100
2,0		≥ M20	VF	NBK1616E39_2.0ISO_AC	16	16	5	39	120
2,5	M20 (1,5xD)			NBK1414D33_2.5ISO_AC	14	14	4	33,75	100
2,5	M20 (2xD)		VF	NBK1414D43_2.5ISO_AC	14	14	4	43,75	100
2,5	M20 (2,5xD)		VF	NBK1615D53_2.5ISO_AC	16	15	4	53,75	120
3,0	M24 (1,5xD)	≥ M30		NBK1616C40_3.0ISO_AC	16	16	3	40,5	120
3,0	M24 (2xD)	≥ M30	VF	NBK1616C52_3.0ISO_AC	16	16	3	52,5	120
3,5	M30 (1,5xD)			NBK2020C50_3.5ISO_AC	20	20	3	50,75	150
3,5	M30 (2xD)		VF	NBK2020C64_3.5ISO_AC	20	20	3	64,75	150

VF = Vibration-Free if you use the entire cutting length, [see page 6.](#)

Internal Axial Coolant  
is most suitable for  
blind holes

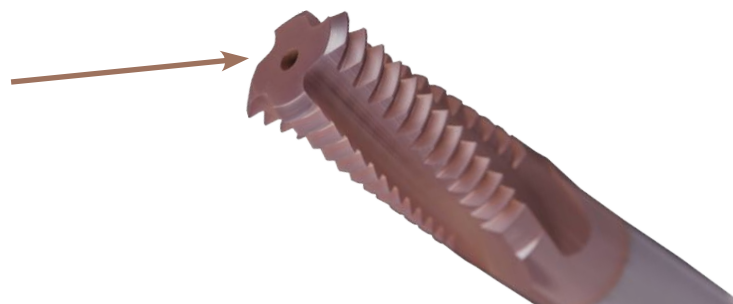

**AC**

TiAlCN coated, Micrograin Carbide

**Tolerance**

The theoretical external diameter of the cutter is laser marked on the tool.

**Shank**

Cylindrical h6, DIN6535 HA

**Flute**

Between 12° and 18°

**Field of application**

Thread Milling of all types of steel

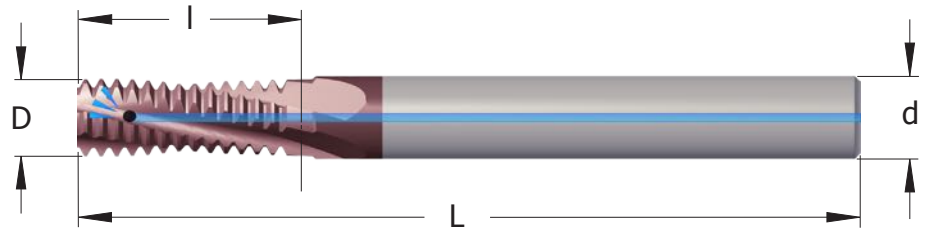
**M****METRIC**

Pitch mm	M coarse	M fine	Vib. free	INTERNAL Part Number	d mm	D mm	Z flutes	l mm	L mm
1,0		≥ M10		NBT0808D17_1.0ISO_AC	8	8	4	17,5	76
1,25	M8 (2xD)	≥ M10		NBT0606C18_1.25ISO_AC	6	6	3	18,12	76
1,5	M10 (2xD)	≥ M12		NBT08075C21_1.5ISO_AC	8	7,5	3	21,75	76
1,5		≥ M16	VF	NBT1212E29_1.5ISO_AC	12	12	5	29,25	100
1,75	M12 (2xD)		VF	NBT0808C27_1.75ISO_AC	8	8	3	27,12	76
1,75	M12 (2xD)			NBT1009C27_1.75ISO_AC	10	9	3	27,12	100
2,0	M14 (2xD)	≥ M18		NBT1010C31_2.0ISO_AC	10	10	3	31	100
2,0	M16 (2xD)	≥ M18	VF	NBT1212D35_2.0ISO_AC	12	12	4	35	100
2,0		≥ M20	VF	NBT1616E39_2.0ISO_AC	16	16	5	39	100

**G/Rp****WHITWORTH PIPE THREAD**

Pitch TPI	Standard	Vib. free	INTERNAL / EXTERNAL Part Number	d mm	D mm	Z flutes	l mm	L mm
28	G 1/16 - 1/8		XBT0606C10_28W_AC	6	6	3	10,43	76
19	G 1/4 - 3/8		XBT1010D22_19W_AC	10	10	4	22,06	100
14	G 1/2 - 7/8		XBT1212D28_14W_AC	12	12	4	28,12	100
11	G 1 - 3	VF	XBT1616D40_11W_AC	16	16	4	40,41	100

VF = Vibration-Free if you use the entire cutting length, [see page 6.](#)

*Internal Radial Coolant  
is most suitable for  
through holes*

**Is it necessary to use a tool with Internal Coolant?**

Most people use tools without Coolant as the price is lower and it is possible to use external Coolant with these tools. The carbide is solid to the center of the tool, making it a stronger tool with less risk for breakage.

In some cases when you have problems with chips you may want to use a tool with Internal Coolant as these tools get the Coolant where you exactly want it and with higher pressure.

- Internal Axial Coolant (NBK) is most suitable for blind holes.
- Internal Radial Coolant (NBT) is most suitable for through holes.

# SOLID CARBIDE THREAD MILLS

## with One Tooth, partial profile

### AC / LC

TiAlCN / AlCrN coated  
Micrograin Carbide

### Tolerance

D 0,3 - 6,0 +0 / -0,020  
D 7,0 - 12,0 +0 / -0,030

### Shank

Cylindrical h6, DIN6535 HA

### Flute

15° right hand spiral

### Field of application

Thread Milling of all types of steel

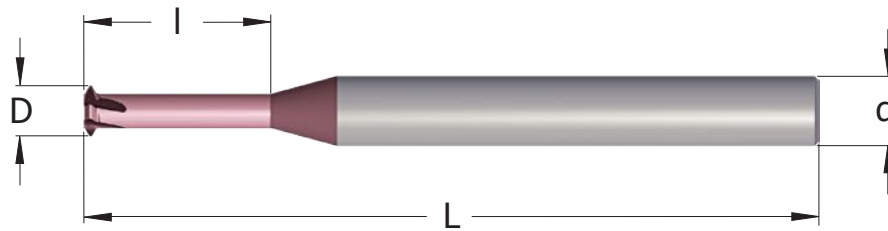

## 60°

### PARTIAL PROFILE 60°

M coarse	M pitch mm	UNC	UNF	UN pitch TPI	INTERNAL Part Number	d mm	D mm	Z flutes	l mm	L mm
M0,5 (2xD)	0,125		No. 0000	160	NS03003C1.3_P60_LC	3	0,37	3	1,3	39
M0,6 (2xD)	0,15				NS03004C1.5_P60_LC	3	0,44	3	1,5	39
M0,8 (2xD)	0,2		No. 000	120	NS03005C2.0_P60_LC	3	0,58	3	2	39
M0,8 (3xD)	0,2		No. 000	120	NS03005C2.7_P60_LC	3	0,58	3	2,7	39
M1 (2xD)	0,2 - 0,25				NS03007C2.5_P60_LC	3	0,72	3	2,5	39
M1 (3xD)	0,2 - 0,25				NS03007C3.2_P60_LC	3	0,72	3	3,2	39
M1,2 (2xD)	0,2 - 0,25		No. 00	95	NS03009C2.9_P60_LC	3	0,92	3	2,9	39
M1,2 (3xD)	0,2 - 0,25		No. 00	95	NS03009C3.9_P60_LC	3	0,92	3	3,9	39
M1,4 (2xD)	0,2 - 0,3				NS03010C3.3_P60_LC	3	1,06	3	3,3	39
M1,4 (3xD)	0,2 - 0,3				NS03010C4.4_P60_LC	3	1,06	3	4,4	39
M1,6 (2xD)	0,2 - 0,35		No. 0	80	NS03012D3.6_P60_LC	3	1,2	4	3,6	39
M1,6 (3xD)	0,2 - 0,35		No. 0	80	NS03012D5.1_P60_LC	3	1,2	4	5,1	39
M1,8 (2xD)	0,35 - 0,4	No. 1	No. 1	72 - 64	NS03014D4.2_P60_LC	3	1,4	4	4,2	39
M1,8 (3xD)	0,35 - 0,4	No. 1	No. 1	72 - 64	NS03014D5.6_P60_LC	3	1,4	4	5,6	39
M2 (2xD)	0,4		No. 2	64	NS03015D4.6_P60_LC	3	1,55	4	4,6	39
M2 (3xD)	0,4		No. 2	64	NS03015D6.2_P60_LC	3	1,55	4	6,2	39
M2 (2xD)	0,35 - 0,4		No. 2	64	NS04015D4_P60_AC	4	1,5	4	4,4	50
M2 (3xD)	0,35 - 0,4		No. 2	64	NS04015D6_P60_AC	4	1,5	4	6,4	50
M2,2 (2xD)	0,45	No. 2		56	NS04016D5_P60_AC	4	1,65	4	5	50
M2,2 (3xD)	0,45	No. 2		56	NS04016D7_P60_AC	4	1,65	4	7,1	50
M2,5 (2xD)	0,45 - 0,5	No. 3	No. 3 - 4	56 - 48	NS04019D5_P60_AC	4	1,9	4	5,5	50
M2,5 (3xD)	0,45 - 0,5	No. 3	No. 3 - 4	56 - 48	NS04019D8_P60_AC	4	1,9	4	8	50
			No. 4	40	NS04021D6_P60_AC	4	2,1	4	6,4	50
			No. 4	40	NS04021D9_P60_AC	4	2,1	4	9,2	50
M3 (2xD)	0,5 - 0,6	No. 5	No. 5	44 - 40	NS04023D6_P60_AC	4	2,3	4	6,5	50
M3 (3xD)	0,5 - 0,6	No. 5	No. 5	44 - 40	NS04023D9_P60_AC	4	2,3	4	9,5	50
M3,5 (2xD)	0,5 - 0,75	No. 6	No. 6	40 - 32	NS04026D7_P60_AC	4	2,6	4	7,6	50
M3,5 (3xD)	0,5 - 0,75	No. 6	No. 6	40 - 32	NS04026D11_P60_AC	4	2,6	4	11,1	50
M4 (2xD)	0,7 - 0,75	No. 8	No. 8	36 - 32	NS0403D9_P60_AC	4	3	4	9	50
M4 (3xD)	0,7 - 0,75	No. 8	No. 8	36 - 32	NS0403D13_P60_AC	4	3	4	13	50
M4,5 (2xD)	0,75 - 1,0	No. 10	No. 10	32 - 24	NS04036D10_P60_AC	4	3,6	4	10	50
M4,5 (3xD)	0,75 - 1,0	No. 10	No. 10	32 - 24	NS04036D14_P60_AC	4	3,6	4	14,3	50
M5 (2xD)	0,75 - 1,0	No. 12	No. 12 - 1/4	32 - 24	NS0404D11_P60_AC	4	4	4	11	50
M5 (3xD)	0,75 - 1,0	No. 12	No. 12 - 1/4	32 - 24	NS0404D16_P60_AC	4	4	4	16	50
M6 (2xD)	1,0 - 1,25	1/4	5/16 - 3/8	24 - 20	NS06045D13_P60_AC	6	4,5	4	13	63
M6 (3xD)	1,0 - 1,25	1/4	5/16 - 3/8	24 - 20	NS06045D19_P60_AC	6	4,5	4	19	76
M8 (2xD)	1,25	5/16	7/16 - 1/2	20 - 18	NS0606E17_P60_AC	6	6	5	17,3	63
M8 (3xD)	1,25	5/16	7/16 - 1/2	20 - 18	NS0606E25_P60_AC	6	6	5	25,3	76
M10 (2xD)	1,5	3/8	9/16 - 3/4	18 - 16	NS08075E22_P60_AC	8	7,5	5	22	63
M10 (3xD)	1,5	3/8	9/16 - 3/4	18 - 16	NS08075E32_P60_AC	8	7,5	5	32	76
M12 (2xD)	1,75	7/16 - 1/2	7/8	14 - 13	NS1009E26_P60_AC	10	9	5	26	76
M12 (3xD)	1,75	7/16 - 1/2	7/8	14 - 13	NS1009E38_P60_AC	10	9	5	38	100
M14 (2xD)	2,0	9/16	≥ 1	12	NS1010E30_P60_AC	10	10	5	30	76
M14 (3xD)	2,0	9/16	≥ 1	12	NS1010E44_P60_AC	10	10	5	44	100
M16 (2xD)	2,0	5/8	≥ 1	12 - 11	NS1212F34_P60_AC	12	12	6	34	83
M16 (3xD)	2,0	5/8	≥ 1	12 - 11	NS1212F50_P60_AC	12	12	6	50	100

# SOLID CARBIDE THREAD MILLS



with One Tooth, full profile

**LC**  
AlCrN coated  
Micrograin Carbide  
**Tolerance**  
D 0,3 - 6,0 +0 / -0,020  
**Shank**  
Cylindrical h6, DIN6535 HA  
**Flute**  
15° right hand spiral  
**Field of application**  
Thread Milling of all types of steel

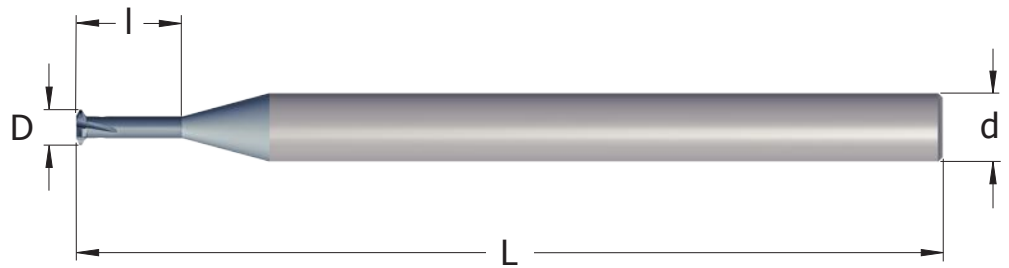

## M

## METRIC

Pitch mm	M coarse	M fine	INTERNAL Part Number	d mm	D mm	Z flutes	l mm	L mm
0,25	M1 (2xD)	≥ M1,4	NS03007C2_0.25ISO_LC	3	0,72	3	2,5	39
0,25	M1 (3xD)	≥ M1,4	NS03007C3_0.25ISO_LC	3	0,72	3	3,5	39
0,25	M1,2 (2xD)	≥ M1,4	NS03009C2_0.25ISO_LC	3	0,92	3	2,9	39
0,25	M1,2 (3xD)	≥ M1,4	NS03009C3_0.25ISO_LC	3	0,92	3	3,9	39
0,3	M1,4 (2xD)		NS03010C3_0.3ISO_LC	3	1,06	3	3,3	39
0,3	M1,4 (3xD)		NS03010C4_0.3ISO_LC	3	1,06	3	4,4	39
0,35	M1,6 (2xD)	≥ M2	NS03012D3_0.35ISO_LC	3	1,2	4	3,6	39
0,35	M1,6 (3xD)	≥ M2	NS03012D5_0.35ISO_LC	3	1,2	4	5,1	39
0,35	M1,8 (2xD)	≥ M2	NS03014D4_0.35ISO_LC	3	1,4	4	4,2	39
0,35	M1,8 (3xD)	≥ M2	NS03014D5_0.35ISO_LC	3	1,4	4	5,6	39
0,4	M2 (2xD)		NS03015D4_0.4ISO_LC	3	1,55	4	4,7	39
0,4	M2 (3xD)		NS03015D6_0.4ISO_LC	3	1,55	4	6,2	39

## Partial Profile vs Full Profile

With a Partial Profile tool it is possible to do different pitches and profiles as the tool only has One Tooth and a profile that is designed to suite several threads.

Some producers make these tools with a very small crest and large profile height to be able to do as many different threads as possible. The disadvantage with this is that the crest will be fragile and the tool diameter small which result in short tool life and tool breakage. Because of this SmiCut produce the Partial Profile thread mills with a more limited area of use.

Full Profile tools will make a thread with higher quality and with these tools it is not so important to drill the exactly correct diameter before threading. Full Profile tools are recommended as first choice.

## One Tooth vs Two Teeth

One Tooth has lower cutting forces and Two teeth has longer tool life.

One Tooth is mainly used for extremely small threads and when Two Teeth is not available, for example UN profiles. Two Teeth tools are recommended as first choice.



Thread Milling  
from M0,5





## with Two Teeth

**AC**  
TiAlCN coated, Micrograin Carbide  
**Tolerance**  
The theoretical external diameter of the cutter is laser marked on the tool.  
**Shank**  
Cylindrical h6, DIN6535 HA  
**Flute**  
15° right hand spiral  
**Field of application**  
Thread Milling of all types of steel

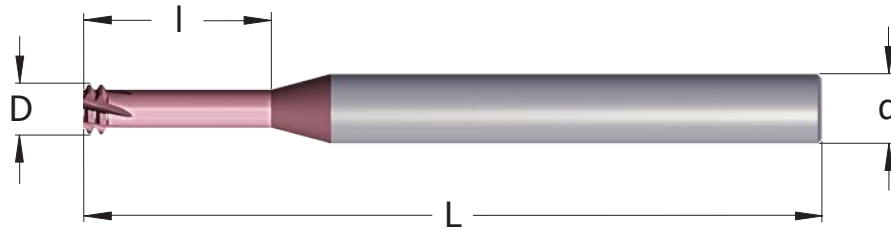

## M METRIC

Pitch mm	M coarse	M fine	INTERNAL Part Number	d mm	D mm	Z flutes	l mm	L mm
0,4	M2 (2xD)		NM04015D4_0.4ISO_AC	4	1,5	4	4,4	50
0,4	M2 (3xD)		NM04015D6_0.4ISO_AC	4	1,5	4	6,4	50
0,45	M2,2 (2xD)		NM04016D5_0.45ISO_AC	4	1,65	4	5,0	50
0,45	M2,2 (3xD)		NM04016D7_0.45ISO_AC	4	1,65	4	7,1	50
0,45	M2,5 (2xD)		NM04019D5_0.45ISO_AC	4	1,9	4	5,5	50
0,45	M2,5 (3xD)		NM04019D8_0.45ISO_AC	4	1,9	4	8	50
0,5	M3 (2xD)	≥ M3,5	NM04023E6_0.5ISO_AC	4	2,3	5	6,5	50
0,5	M3 (3xD)	≥ M3,5	NM04023E9_0.5ISO_AC	4	2,3	5	9,5	50
0,6	M3,5 (2xD)		NM04026E7_0.6ISO_AC	4	2,6	5	7,6	50
0,6	M3,5 (3xD)		NM04026E11_0.6ISO_AC	4	2,6	5	11,1	50
0,7	M4 (2xD)		NM0403E9_0.7ISO_AC	4	3	5	9	50
0,7	M4 (3xD)		NM0403E13_0.7ISO_AC	4	3	5	13	50
0,75	M4,5 (2xD)	≥ M5	NM04034E10_0.75ISO_AC	4	3,4	5	10	50
0,75	M4,5 (3xD)	≥ M5	NM04034E14_0.75ISO_AC	4	3,4	5	14,3	50
0,8	M5 (2xD)		NM04038E11_0.8ISO_AC	4	3,8	5	11	50
0,8	M5 (3xD)		NM04038E16_0.8ISO_AC	4	3,8	5	16	50
1,0	M6 (2xD)	≥ M8	NM06045E13_1.0ISO_AC	6	4,5	5	13	63
1,0	M6 (3xD)	≥ M8	NM06045E19_1.0ISO_AC	6	4,5	5	19	76
1,25	M8 (2xD)	≥ M10	NM0606E17_1.25ISO_AC	6	6	5	17,3	63
1,25	M8 (3xD)	≥ M10	NM0606E25_1.25ISO_AC	6	6	5	25,3	76
1,5	M10 (2xD)	≥ M12	NM08075E22_1.5ISO_AC	8	7,5	5	22	63
1,5	M10 (3xD)	≥ M12	NM08075E32_1.5ISO_AC	8	7,5	5	32	76
1,75	M12 (2xD)		NM1009E26_1.75ISO_AC	10	9	5	26	76
1,75	M12 (3xD)		NM1009E38_1.75ISO_AC	10	9	5	38	100
2,0	M14 (2xD)	≥ M18	NM1010E30_2.0ISO_AC	10	10	5	30	76
2,0	M14 (3xD)	≥ M18	NM1010E44_2.0ISO_AC	10	10	5	44	100
2,0	M16 (2xD)	≥ M18	NM1212F34_2.0ISO_AC	12	12	6	34	83
2,0	M16 (3xD)	≥ M18	NM1212F50_2.0ISO_AC	12	12	6	50	100

### When should I use Two Teeth Thread Mills?

The first choice for thread milling is always ThreadBurr, NB-tools. They have the full thread length and deburr the entrance of the thread in the same operation.

In some cases when it is difficult to achieve good results, the NM-tools with Two Teeth can be a solution as the cutting forces are lower. For example, long threads and materials that are difficult to machine.

With NM-tools you make several passes axially instead of one, even so the machining time will not be so much longer as you can increase the feed and the tool has more flutes than the NB-tools.

Available from  
Ø1,5 to Ø12 mm



## with Chamfer

**AC**

TiAlCN coated, Micrograin Carbide

**Tolerance**

The theoretical external diameter of the cutter is laser marked on the tool.

**Shank**

Cylindrical h6, DIN6535 HA

**Flute**

Between 12° and 18°

**Field of application**

Thread Milling of all types of steel

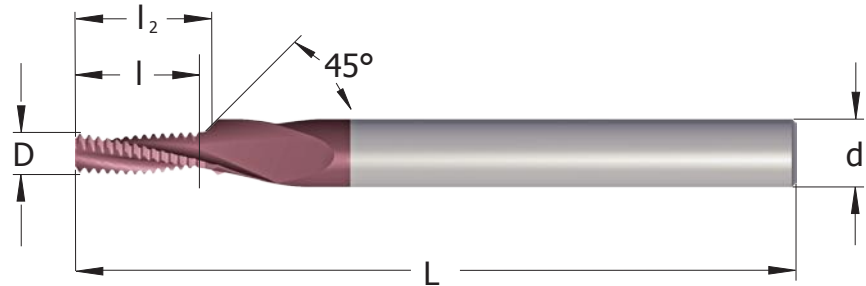
**M****METRIC**

Pitch mm	M coarse	Vib. free	INTERNAL Part Number	d mm	D mm	Z flutes	l mm	l <sub>2</sub> mm	L mm
0,5	M3 (1,5xD)		NF06023C5_0.5ISO_AC	6	2,3	3	5,25	5,85	63
0,5	M3 (2xD)		NF06023C6_0.5ISO_AC	6	2,3	3	6,75	7,35	63
0,5	M3 (2,5xD)	VF	NF06023C8_0.5ISO_AC	6	2,3	3	8,25	8,85	63
0,5	M3 (3xD)	VF	NF06023C9_0.5ISO_AC	6	2,3	3	9,75	10,35	63
0,7	M4 (1,5xD)		NF0603C7_0.7ISO_AC	6	3	3	7,35	8,2	63
0,7	M4 (2xD)		NF0603C8_0.7ISO_AC	6	3	3	8,75	9,6	63
0,7	M4 (2,5xD)	VF	NF0603C10_0.7ISO_AC	6	3	3	10,85	11,7	63
0,7	M4 (3xD)	VF	NF0603C12_0.7ISO_AC	6	3	3	12,95	13,8	63
0,8	M5 (1,5xD)		NF06038C8_0.8ISO_AC	6	3,8	3	8,4	9,4	63
0,8	M5 (2xD)		NF06038C10_0.8ISO_AC	6	3,8	3	10,8	11,8	63
0,8	M5 (2,5xD)	VF	NF06038C13_0.8ISO_AC	6	3,8	3	13,2	14,2	63
0,8	M5 (3xD)	VF	NF06038C16_0.8ISO_AC	6	3,8	3	16,4	17,4	63
1,0	M6 (1,5xD)		NF08045C10_1.0ISO_AC	8	4,5	3	10,5	11,75	63
1,0	M6 (2xD)		NF08045C13_1.0ISO_AC	8	4,5	3	13,5	14,75	63
1,0	M6 (2,5xD)	VF	NF08045C16_1.0ISO_AC	8	4,5	3	16,5	17,75	63
1,25	M8 (1,5xD)		NF1006C14_1.25ISO_AC	10	6	3	14,37	16	76
1,25	M8 (2xD)		NF1006C18_1.25ISO_AC	10	6	3	18,12	19,75	76
1,25	M8 (2,5xD)	VF	NF1006C21_1.25ISO_AC	10	6	3	21,87	23,5	76
1,5	M10 (1,5xD)		NF12075C17_1.5ISO_AC	12	7,5	3	17,25	19,25	83
1,5	M10 (2xD)		NF12075C21_1.5ISO_AC	12	7,5	3	21,75	23,75	83
1,5	M10 (2,5xD)	VF	NF12075C27_1.5ISO_AC	12	7,5	3	27,75	29,75	83
1,75	M12 (1,5xD)		NF1409C20_1.75ISO_AC	14	9	3	20,12	22,5	89
1,75	M12 (2xD)		NF1409C27_1.75ISO_AC	14	9	3	27,12	29,5	89
1,75	M12 (2,5xD)	VF	NF1409C32_1.75ISO_AC	14	9	3	32,37	34,75	89

VF = Vibration-Free if you use the entire cutting length, [see page 6](#).**Do I have to chamfer the thread?**

The answer is yes if it is on the drawing and you do not have the authority to change it.

In practical terms, it is not necessary as the thread mills from SmiCut (ThreadBurr) deburr the entrance of the thread in the same operation as it is milling the thread.

First choice is, try to avoid the unnecessary chamfering operation. Second choice is, use NF-tools to make the chamfer and the thread with the same tool.

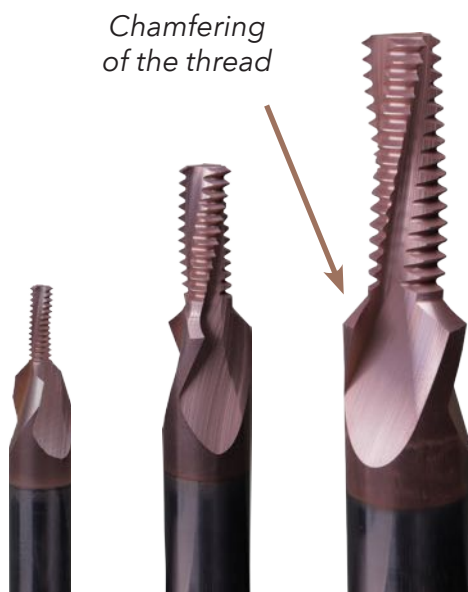

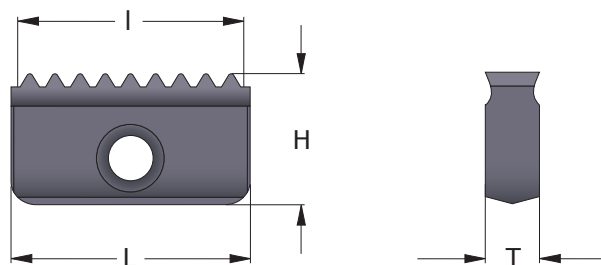

## M METRIC

Pitch mm	M coarse	M fine	INTERNAL Part Number	I mm	L mm	T mm	H mm	Cutting Edges
0,5		≥ M13	14I_0.5ISO_FC	14	14	3,1	7,5	2
1,0		≥ M14	14I_1.0ISO_FC	14	14	3,1	7,5	2
1,0		≥ M22	21I_1.0ISO_FC	21	21	4,7	12	2
1,5		≥ M16	14I_1.5ISO_FC	13,5	14	3,1	7,5	2
1,5		≥ M22	21I_1.5ISO_FC	21	21	4,7	12	2
1,5		≥ M33	30I_1.5ISO_FC	30	30	5,5	16	2
2,0	M16	≥ M18	14I_2.0ISO_FC	14	14	3,1	7,5	2
2,0		≥ M22	21I_2.0ISO_FC	20	21	4,7	12	2
2,0		≥ M33	30I_2.0ISO_FC	30	30	5,5	16	2
2,0		≥ M56	40I_2.0ISO_FC	40	40	6,3	20	2
2,5	M18-M22		14I_2.5ISO_FC	12,5	14	3,1	7,5	2
3,0	M24	≥ M30	21I_3.0ISO_FC	21	21	4,7	12	2
3,0		≥ M36	30I_3.0ISO_FC	30	30	5,5	16	2
3,0		≥ M56	40I_3.0ISO_FC	39	40	6,3	20	2
3,5	M30-M33		21I_3.5ISO_FC	21	21	4,7	12	2
4,0	M36-M39	≥ M42	30I_4.0ISO_FC	28	30	5,5	16	2
4,0		≥ M60	40I_4.0ISO_FC	40	40	6,3	20	2
4,5	M42-M45		30I_4.5ISO_FC	27	30	5,5	16	2
5,0	M48-M52		30I_5.0ISO_FC	30	30	5,5	16	2
5,5	M56-M60		30I_5.5ISO_FC	27,5	30	5,5	16	2
6,0	M64-M68	≥ M72	40I_6.0ISO_FC	36	40	6,3	20	2

## G/Rp WHITWORTH PIPE THREAD

Pitch TPI	Norm	INTERNAL / EXTERNAL Part Number	I mm	L mm	T mm	H mm	Cutting Edges
19	G 3/8	14X_19W_FC	13,37	14	3,1	7,5	2
14	G 1/2 - 5/8	14X_14W_FC	12,7	14	3,1	7,5	2
14	G 5/8 - 7/8	21X_14W_FC	19,96	21	4,7	12	2
11	G 1	14X_11W_FC	13,85	14	3,1	7,5	1
11	G 1	21X_11W_FC	20,78	21	4,7	12	2
11	G 1 1/8	30X_11W_FC	30,02	30	5,5	16	2
11	G ≥ 2	40X_11W_FC	39,25	40	6,3	20	2

## R/Rc BSPT PIPE THREAD

Pitch TPI	Norm	INTERNAL / EXTERNAL Part Number	I mm	L mm	T mm	H mm	Cutting Edges
19	Rc 3/8	14X_19BSPT_FC	13,37	14	3,1	7,5	1
14	Rc 1/2	14X_14BSPT_FC	12,7	14	3,1	7,5	1
14	Rc 3/4	21X_14BSPT_FC	19,96	21	4,7	12	1
11	Rc 1	21X_11BSPT_FC	20,78	21	4,7	12	1
11	Rc 1 1/8	30X_11BSPT_FC	30,02	30	5,5	16	1
11	Rc ≥ 2	40X_11BSPT_FC	39,25	40	6,3	20	1

## PG STEEL CONDUIT THREAD DIN 40430

Pitch TPI	Norm	INTERNAL / EXTERNAL Part Number	I mm	L mm	T mm	H mm	Cutting Edges
18	Pg 9 - 16	14X_18PG_FC	14,11	14	3,1	7,5	2
18	Pg 13,5 - 16	21X_18PG_FC	21	21	4,7	12	2
16	Pg 21 - 48	21X_16PG_FC	20,64	21	4,7	12	2
16	Pg 29 - 48	30X_16PG_FC	30	30	5,5	16	2

## UN

## UNIFIED

Pitch TPI	UNC	UNF	UNEF	INTERNAL Part Number	I mm	L mm	T mm	H mm	Cutting Edges
32				14I_32UN_FC	13,49	14	3,1	7,5	2
28				14I_28UN_FC	13,61	14	3,1	7,5	2
24			9/16 - 5/8	14I_24UN_FC	13,75	14	3,1	7,5	2
20			3/4 - 1	14I_20UN_FC	13,97	14	3,1	7,5	2
20			7/8 - 1	21I_20UN_FC	20,32	21	4,7	12	2
20				30I_20UN_FC	29,21	30	5,5	16	2
18		5/8	1 1/16 - 1 11/16	14I_18UN_FC	14,11	14	3,1	7,5	2
18			1 1/16 - 1 11/16	21I_18UN_FC	21,17	21	4,7	12	2
18			1 1/4 - 1 11/16	30I_18UN_FC	29,63	30	5,5	16	2
16		3/4		14I_16UN_FC	12,7	14	3,1	7,5	2
16				21I_16UN_FC	20,64	21	4,7	12	2
16				30I_16UN_FC	30,16	30	5,5	16	2
16				40I_16UN_FC	39,69	40	6,3	20	2
14		7/8		14I_14UN_FC	12,7	14	3,1	7,5	2
14		7/8		21I_14UN_FC	19,96	21	4,7	12	2
12		1-1 1/2		14I_12UN_FC	12,7	14	3,1	7,5	2
12		1-1 1/2		21I_12UN_FC	21,12	21	4,7	12	2
12		1 3/8 - 1 1/2		30I_12UN_FC	29,63	30	5,5	16	2
12				40I_12UN_FC	40,22	40	6,3	20	2
10	3/4			14I_10UN_FC	12,7	14	3,1	7,5	2
8	1			21I_8UN_FC	19,05	21	4,7	12	2
8				30I_8UN_FC	28,57	30	5,5	16	2
8				40I_8UN_FC	38,1	40	6,3	20	2
7	1 1/8 - 1 1/4			21I_7UN_FC	21,77	21	4,7	12	2
6	1 1/2			30I_6UN_FC	29,63	30	5,5	16	2
6				40I_6UN_FC	38,1	40	6,3	20	2
5	1 3/4			30I_5UN_FC	30,48	30	5,5	16	1
4	3 - 4			40I_4UN_FC	38,1	40	6,3	20	2

## NPT

## NPT PIPE THREAD

Pitch TPI	Norm	INTERNAL / EXTERNAL Part Number	I mm	L mm	T mm	H mm	Cutting Edges
18	3/8	14X_18NPT_FC	12,7	14	3,1	7,5	1
14	1/2 - 5/8	14X_14NPT_FC	12,7	14	3,1	7,5	1
14	3/4 - 7/8	21X_14NPT_FC	19,96	21	4,7	12	1
11,5	1	21X_11.5NPT_FC	19,88	21	4,7	12	1
11,5	1 1/4 - 2	30X_11.5NPT_FC	28,71	30	5,5	16	1
8	≥ 2 1/2	30X_8NPT_FC	28,58	30	5,5	16	1
8	≥ 2 1/2	40X_8NPT_FC	38,1	40	6,3	20	1

## NPTF

## NPTF DRYSEAL PIPE THREAD

Pitch TPI	Norm	INTERNAL / EXTERNAL Part Number	I mm	L mm	T mm	H mm	Cutting Edges
18	3/8	14X_18NPTF_FC	12,7	14	3,1	7,5	1
14	1/2 - 5/8	14X_14NPTF_FC	12,7	14	3,1	7,5	1
14	3/4 - 7/8	21X_14NPTF_FC	19,96	21	4,7	12	1
11,5	1	21X_11.5NPTF_FC	19,88	21	4,7	12	1
11,5	1 1/4 - 2	30X_11.5NPTF_FC	28,71	30	5,5	16	1
8	≥ 2 1/2	30X_8NPTF_FC	28,58	30	5,5	16	1
8	≥ 2 1/2	40X_8NPTF_FC	38,1	40	6,3	20	1

- Part number with I is for internal thread profile.
- Part number with X is for in- and external thread profile.
- For external profile indicate E instead of I. The price is 10% higher for E.

# THREAD MILLING TOOLHOLDERS

## Shank Toolholders with One Pocket

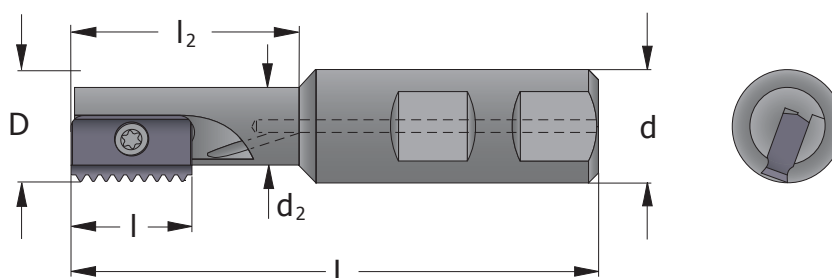

D mm	d mm	d <sub>2</sub> mm	Part Number	l mm	l <sub>2</sub> mm	L mm	No. of Inserts
12	20	8,9	SR0012F14	14	20	75	1
14,5	20	11,2	SR0014H14	14	25	85	1
17	20	13,4	SR0017H14	14	30	85	1
18	20	14,4	SR0018H21	21	30	85	1
21	20	16,5	SR0021H21	21	40	94	1
25	20	-	SR0025K21	21	-	125	1
29	25	22,4	SR0029J30	30	50	110	1
31	25	-	SR0031M30	30	-	150	1
38	32	-	SR0038M30	30	-	150	1
48	40	35	SR0048M40	40	78	153	1
48	40	-	SR0048R40	40	-	210	1

## Shank Toolholders with Two Pockets

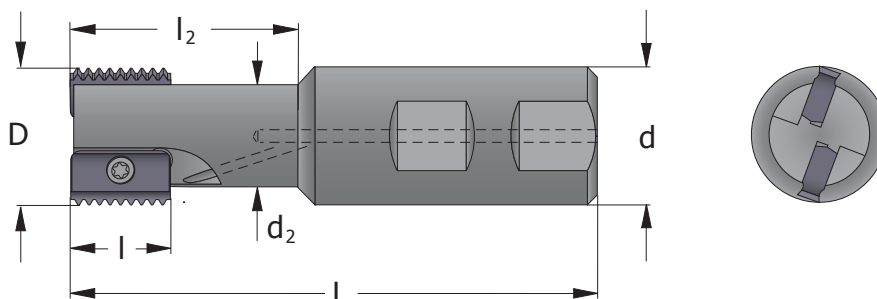

D mm	d mm	d <sub>2</sub> mm	Part Number	l mm	l <sub>2</sub> mm	L mm	No. of Inserts
20	20	16	SR0020H14-2	14	41	93	2
30	25	24	SR0030J21-2	21	52	108	2
40	32	30	SR0040L30-2	30	70	130	2
50	40	38	SR0050M40-2	40	78	153	2

### When should I use Thread Milling Inserts?

We recommend Solid Carbide Thread Mills as the first choice because they are much more efficient tools. In most cases, they will result in a lower cost per thread.

However, the advantage of an Indexable Thread Milling Cutter is that you can use inserts with different pitches and profiles on the same cutter body. This can be a good alternative if you only need to make a few threads.

- Solid Carbide Thread Mills are available up to 4,0 mm pitch.
- Thread Milling Inserts are available up to 6,0 mm pitch.



# THREAD MILLING TOOLHOLDERS

## Shank Toolholders in Carbide

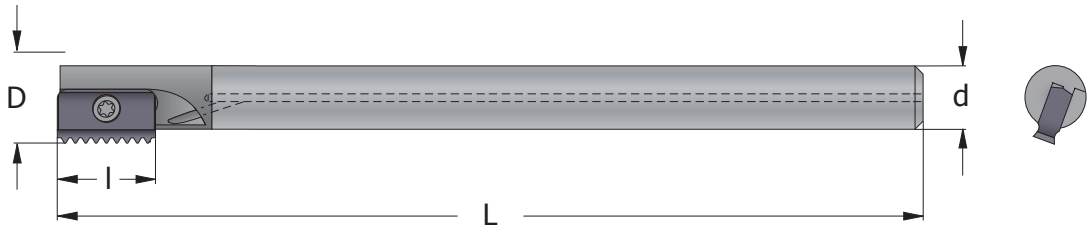

D mm	d mm	Part Number	l mm	L mm	No. of Inserts
13	10	SR0013J14C	14	150	1
15	12	SR0015K14C	14	175	1
21	16	SR0021M21C	21	200	1
27	20	SR0027S30C	30	260	1
33	25	SR0033T30C	30	270	1

## Face Mill Cutters

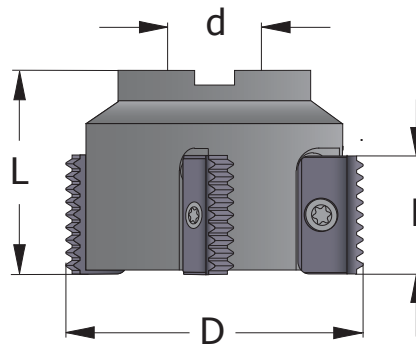

D mm	d mm	Part Number	l mm	L mm	No. of Inserts
63	22	SR0063C21-5	21	50	5
63	22	SR0063C30-4	30	50	4
80	27	SR0080D30-4	30	55	4
100	32	SR0100D30-4	30	60	4
80	27	SR0080D40-4	40	65	4
100	32	SR0100E40-4	40	70	4

## Spare Parts

Insert mm	Screw to insert	Torx key
14	S14	K14
21	S21	K21
30	S30	K30
40	S40	K40



## Spiral Fluted

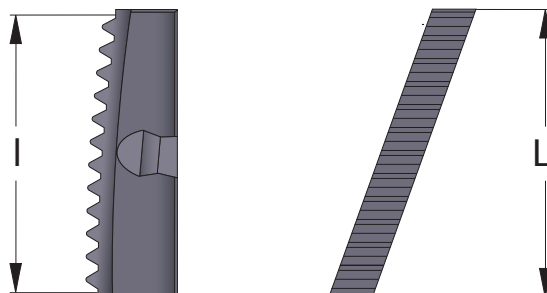

### M

### METRIC

Pitch mm	M fine	INTERNAL Part Number	l mm	L mm	Cutting Edges
1,0	≥ M27	H23I_1.0ISO_FC	27	27	1
1,5	≥ M27	H23I_1.5ISO_FC	27	27	1
1,5	≥ M36	H32I_1.5ISO_FC	31,5	32	1
1,5	≥ M52	H45I_1.5ISO_FC	36	37	1
1,5	≥ M68	H63I_1.5ISO_FC	37,5	38	1
2,0	≥ M27	H23I_2.0ISO_FC	26	27	1
2,0	≥ M36	H32I_2.0ISO_FC	32	32	1
2,0	≥ M52	H45I_2.0ISO_FC	36	37	1
2,0	≥ M68	H63I_2.0ISO_FC	38	38	1
3,0	≥ M30	H23I_3.0ISO_FC	27	27	1
3,0	≥ M39	H32I_3.0ISO_FC	30	32	1
3,0	≥ M52	H45I_3.0ISO_FC	36	37	1
3,0	≥ M72	H63I_3.0ISO_FC	36	38	1
3,5	≥ M30	H23I_3.5ISO_FC	24,5	27	1
4,0	≥ M36	H23I_4.0ISO_FC	24	27	1
4,0	≥ M42	H32I_4.0ISO_FC	32	32	1
4,0	≥ M56	H45I_4.0ISO_FC	36	37	1
4,0	≥ M72	H63I_4.0ISO_FC	36	38	1
4,5	≥ M42	H32I_4.5ISO_FC	31,5	32	1
5,0	≥ M48	H32I_5.0ISO_FC	30	32	1
5,5	≥ M56	H45I_5.5ISO_FC	33	37	1
6,0	≥ M64	H45I_6.0ISO_FC	36	37	1
6,0	≥ M80	H63I_6.0ISO_FC	36	38	1

### G/Rp

### WHITWORTH PIPE THREAD

Pitch TPI	Standard	INTERNAL / EXTERNAL Part Number	l mm	L mm	Cutting Edges
14	G ≥ 7/8	H23X_14W_FC	25,4	27	1
11	G ≥ 1	H23X_11W_FC	25,4	27	1
11	G ≥ 1 1/8	H32X_11W_FC	30,02	32	1
11	G ≥ 1 3/4	H45X_11W_FC	36,95	37	1
11	G ≥ 2 1/2	H63X_11W_FC	36,95	38	1

### R/Rc

### BSPT PIPE THREAD

Pitch TPI	Standard	INTERNAL / EXTERNAL Part Number	l mm	L mm	Cutting Edges
11	Rc ≥ 1	H23X_11BSPT_FC	25,4	27	1
11	Rc ≥ 1 1/8	H32X_11BSPT_FC	30,02	32	1
11	Rc ≥ 1 3/4	H45X_11BSPT_FC	36,95	37	1
11	Rc ≥ 2 1/2	H63X_11BSPT_FC	36,95	38	1

## NPT

## NPT PIPE THREAD

Pitch TPI	Standard	INTERNAL / EXTERNAL Part Number	l mm	L mm	Cutting Edges
11,5	1 - 2	H23X_11.5NPT_FC	26,5	27	1
11,5	1 <sup>1</sup> / <sub>4</sub> - 2	H32X_11.5NPT_FC	30,92	32	1
11,5	2	H45X_11.5NPT_FC	35,34	37	1
8	2 <sup>1</sup> / <sub>2</sub>	H45X_8NPT_FC	34,93	37	1
8	3	H63X_8NPT_FC	38,1	38	1

## NPTF

## NPTF PIPE THREAD

Pitch TPI	Standard	INTERNAL / EXTERNAL Part Number	l mm	L mm	Cutting Edges
11,5	1 - 2	H23X_11.5NPTF_FC	26,5	27	1
11,5	1 <sup>1</sup> / <sub>4</sub> - 2	H32X_11.5NPTF_FC	30,92	32	1

## UN

## UNIFIED

Pitch TPI	Standard	INTERNAL Part Number	l mm	L mm	Cutting Edges
24	≥ 1	H23I_24UN_FC	26,46	27	1
20	≥ 1 <sup>1</sup> / <sub>16</sub>	H23I_20UN_FC	26,67	27	1
20	≥ 1 <sup>3</sup> / <sub>8</sub>	H32I_20UN_FC	31,75	32	1
18	≥ 1 <sup>1</sup> / <sub>16</sub>	H23I_18UN_FC	26,81	27	1
18	≥ 1 <sup>3</sup> / <sub>8</sub>	H32I_18UN_FC	31,04	32	1
16	≥ 1 <sup>1</sup> / <sub>8</sub>	H23I_16UN_FC	26,99	27	1
16	≥ 1 <sup>1</sup> / <sub>2</sub>	H32I_16UN_FC	31,75	32	1
16	≥ 2	H45I_16UN_FC	36,51	37	1
16	≥ 2 <sup>5</sup> / <sub>8</sub>	H63I_16UN_FC	38,1	38	1
12	≥ 1 <sup>1</sup> / <sub>8</sub>	H23I_12UN_FC	25,4	27	1
12	≥ 1 <sup>1</sup> / <sub>2</sub>	H32I_12UN_FC	31,75	32	1
12	≥ 2	H45I_12UN_FC	35,98	37	1
12	≥ 2 <sup>3</sup> / <sub>4</sub>	H63I_12UN_FC	38,1	38	1
8	≥ 1 <sup>1</sup> / <sub>8</sub>	H23I_8UN_FC	25,4	27	1
8	≥ 1 <sup>1</sup> / <sub>2</sub>	H32I_8UN_FC	31,75	32	1
8	≥ 2 <sup>1</sup> / <sub>8</sub>	H45I_8UN_FC	34,93	37	1
8	≥ 2 <sup>3</sup> / <sub>4</sub>	H63I_8UN_FC	38,1	38	1
7	≥ 1 <sup>1</sup> / <sub>4</sub>	H23I_7UN_FC	25,4	27	1
6	≥ 1 <sup>5</sup> / <sub>8</sub>	H32I_6UN_FC	29,63	32	1
6	≥ 2 <sup>1</sup> / <sub>8</sub>	H45I_6UN_FC	33,97	37	1
6	≥ 2 <sup>7</sup> / <sub>8</sub>	H63I_6UN_FC	38,1	38	1
5	≥ 1 <sup>3</sup> / <sub>4</sub>	H32I_5UN_FC	30,48	32	1

# THREAD MILLING TOOLHOLDERS

## Spiral Fluted Shank Toolholders

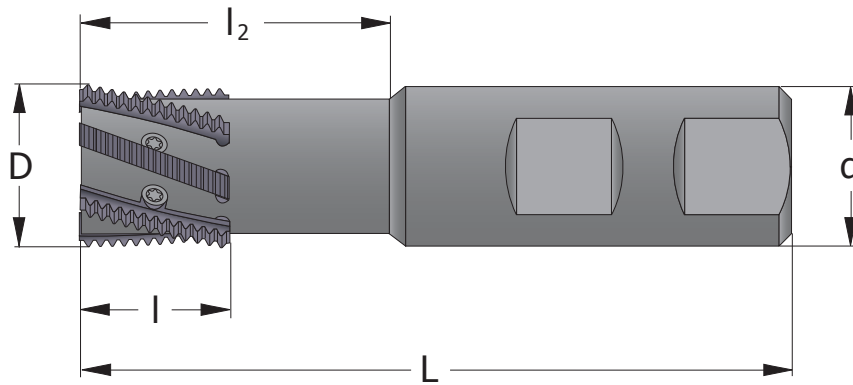

D mm	d mm	Part Number	l mm	$l_2$ mm	L mm	No. of Inserts
23	25	SRH23-2	27	50	110	2
23	25	SRH23M-2	27	75	150	2
32	32	SRH32-5	32	60	130	5
32	32	SRH32P-5	32	90	180	5
45	32	SRH45-6	37	-	130	6

*Spiral fluted for  
efficient machining*



# THREAD MILLING TOOLHOLDERS

## Spiral Fluted Face Mill Cutters

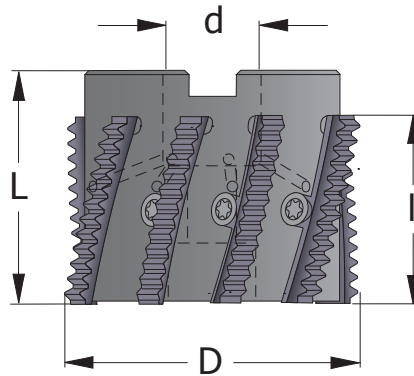

D mm	d mm	Part Number	l mm	L mm	No. of Inserts
32	16	SRH32-5M	32	52	5
45	22	SRH45-6M	37	60	6
63	22	SRH63-9	38	50	9

### Spare Parts

Insert mm	Screw to insert	Torx key
H23	S23	K21
H32	S32	K22
H45	S45	K40
H63	S63	K40



# FourCut

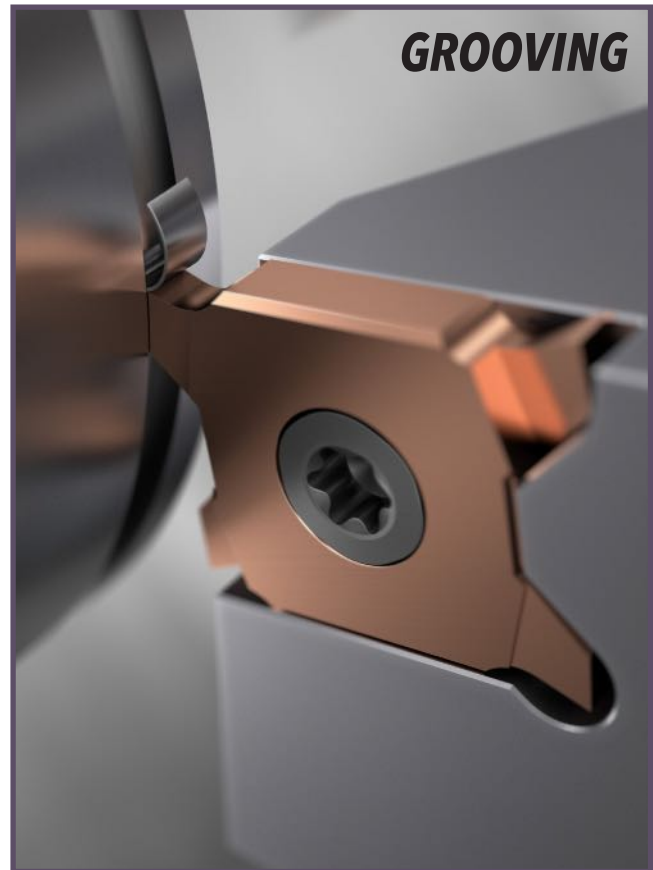

**Same toolholder for THREADING and GROOVING!**

---

## LC - New FourCut Grade *see page 43*

HC  
AlTiSiN coating



LC  
AlCrN coating



*Choose between the grades HC and LC  
for maximal productivity.*

# THREAD TURNING

## CONTENTS



Technical Information	40
FourCut Threading Tools	
Threading Inserts	46
Grooving Inserts	50
External Toolholders	52
Triangular Threading Tools	
Threading Inserts	54
External Toolholders	64
Internal Toolholders	65
U-type Threading Tools	
Threading Inserts	66
External Toolholders	68
Internal Toolholders	69
Micro Threading Tools	
Threading Inserts	70
Toolholders	71
Thread Designations	126
Common Thread Profiles	129

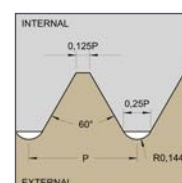
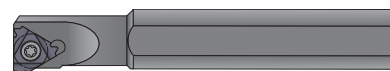
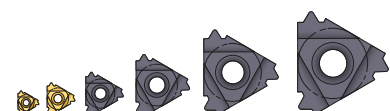
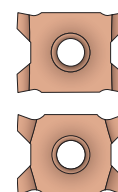
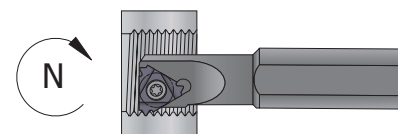



## Advantages

# Cost-effective

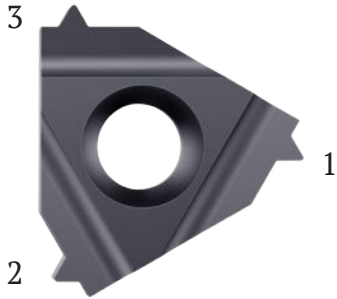

### Four Cutting Edges - for the Price of Three

As the price for the inserts are the same, the FourCut threading insert is 25% cheaper as it has four cutting edges instead of three.

# Strength

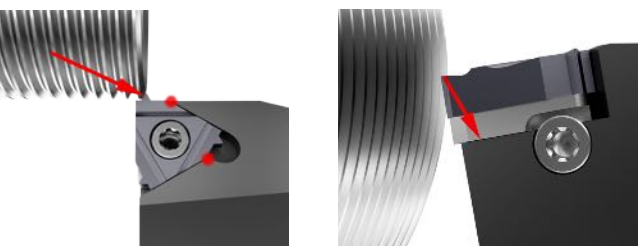
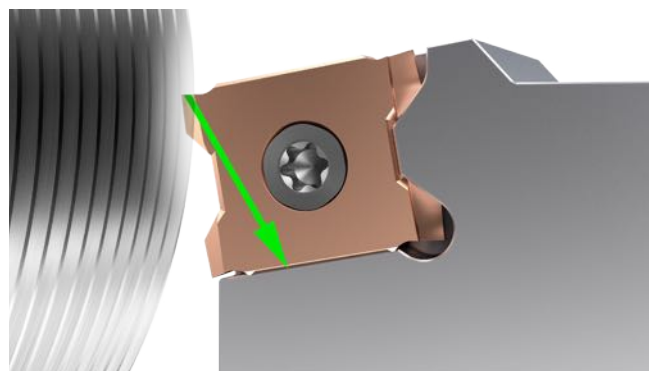
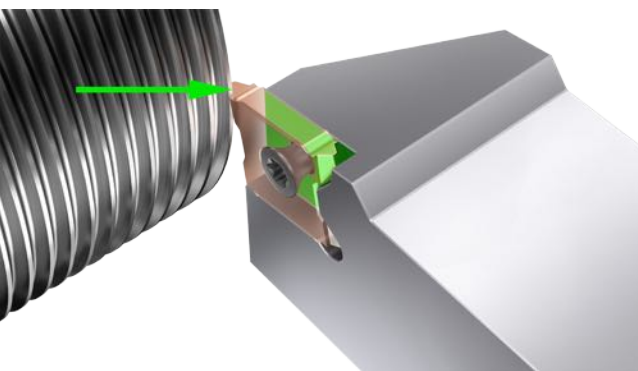

### Strong and Stable Machining

FourCut is a vertical insert. This gives a very strong insert. The cutting forces go in to the insert and you don't need any anvil as the carbide insert take up the forces.

- No problem with the side forces as the flat surface of the insert take up these forces.
- No weak point on the toolholder.

# Accessibility

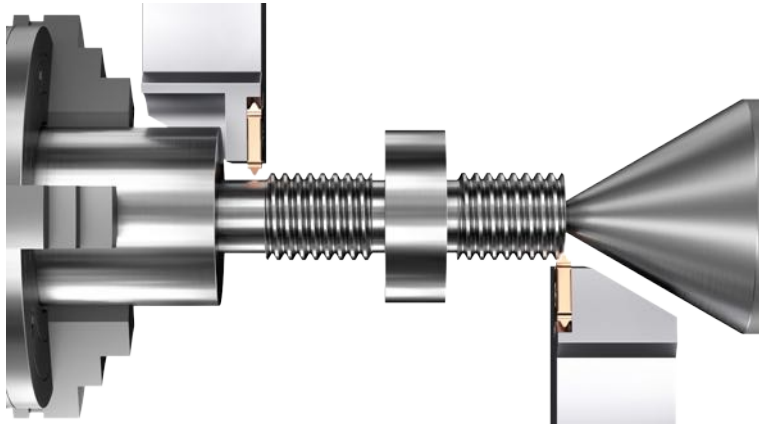

Minimum Waste of Material

## Problem Solver with Benefits

With a vertical insert the accessibility gives you two main advantages.

- Less waste of material as you don't need to turn away material to be able to make the thread.
- As you have more space you can use a live center when you are threading small diameters. This will give you a stable machining and a better quality of the thread.

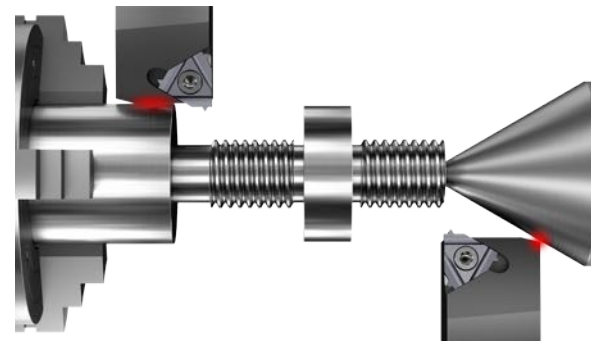

# Optimal Clearance

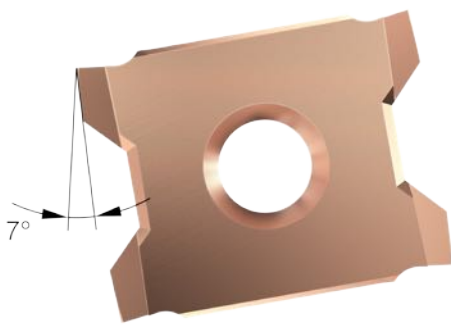

7° is optimal

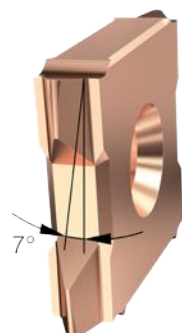

## No need for Anvils - Only One Toolholder

The inserts are ground on all sides with a complex grinding technology on 6-axis grinding machines to get a 7° clearance angle all around the thread profile which gives the following advantages:

- Extra clearance on the flanks gives better cutting conditions.
- Same toolholder for different helix angles as the extra clearance allow you to have bigger difference in helix angle.
- Less clearance on the radius gives stronger cutting edge and longer tool life.

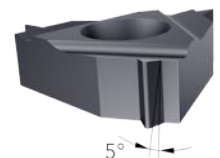

# THREAD TURNING

## Helix Angle

To get good cutting conditions the threading insert has to be inclined into the toolholder at approximately the same angle as the helix angle of the thread.

$$\tan \lambda = \frac{P}{\pi \times D}$$

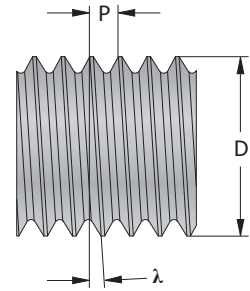

## FourCut

The FourCut inserts has extra clearance on the flanks and therefore it is not so important to have correct helix angle. The standard toolholder has 2° helix angle and it is possible to make almost all threads with the same holder.

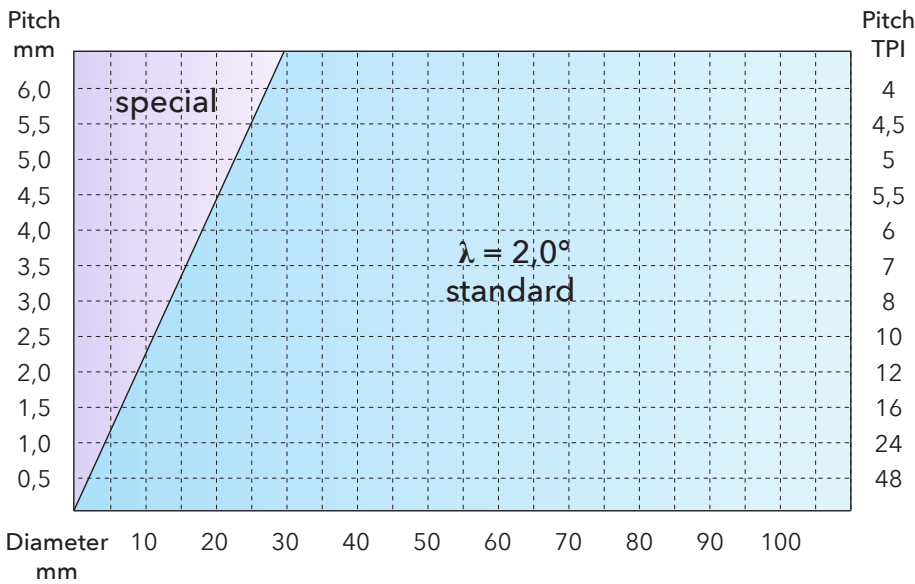

## Triangular Insert

On the triangular inserts it is more important to have a similar helix angle on the toolholder as the thread. The standard toolholder has an anvil which gives 1,5° helix angle. If you need bigger or smaller, you just change the anvil.

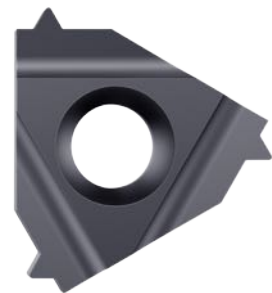
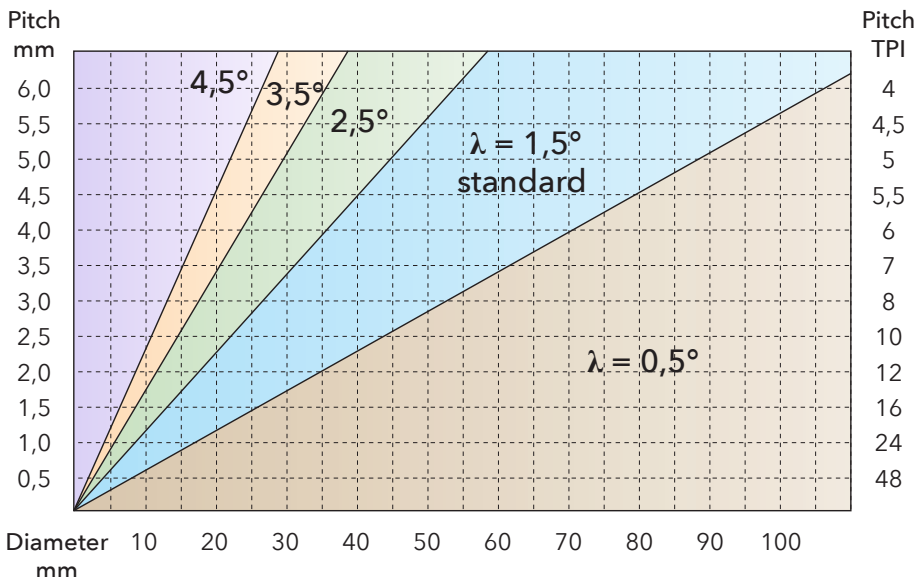

# THREAD TURNING

## Carbide Grades



### FourCut

With FourCut you choose between two different grades for best performance.

HC is best for harder materials and high-heat applications, while LC offers a balance of toughness and heat resistance, ideal for a wide range of applications and materials.



Micrograin Carbide with AlTiSiN coating. All-round grade, high hardness and heat resistance. Use cutting data according to the tables.



Micrograin Carbide with AlCrN coating. All-round grade, combination of toughness and heat resistance. Use cutting data according to the tables.

### Triangular Insert

You don't need to choose a grade for our triangular inserts. We use FC as our all-round grade, which performs great in most applications.

For internal thread turning of small dimensions, we utilize the BC grade.



Micrograin Carbide with TiAlN coating. All-round grade with high heat resistance. Use cutting data according to the tables.



Micrograin Carbide with TiN coating. Suitable for internal thread turning of small dimensions. Cutting speed 40% less than FC.

### Select Grade

MATERIAL	Hardness HB	Tensile Strength N/mm <sup>2</sup>	FourCut		Triangular	
			First Choice	Second Choice	First Choice	
Steel	Low carbon, C < 0,25%	< 120	< 400	LC	HC	FC
	Medium carbon, C < 0,55%	< 200	< 700	LC	HC	FC
	High carbon, C < 0,85%	< 250	< 850	LC	HC	FC
	Low alloy	< 250	< 850	LC	HC	FC
	High alloy	< 350	< 1200	HC	LC	FC
	Hardened, HRC < 45			HC	LC	FC
	Hardened, HRC < 55			HC	LC	FC
	Hardened, HRC < 65			HC	LC	FC
Cast iron	Lamellar graphite	< 150	< 500	LC	HC	FC
	Lamellar graphite	< 300	< 1000	LC	HC	FC
	Nodular graphite, malleable	< 200	< 700	LC	HC	FC
	Nodular graphite, malleable	< 300	< 1000	LC	HC	FC
Stainless steel	Free machining	< 250	< 850	HC	LC	FC
	Austenitic	< 250	< 850	HC	LC	FC
Titanium	Ferritic and austenitic	< 300	< 1000	HC	LC	FC
	Unalloyed	< 200	< 700	HC	LC	FC
Nickel	Alloyed	< 270	< 900	HC	LC	FC
	Alloyed	< 350	< 1250	HC	LC	FC
	Alloyed	< 150	< 500	LC	HC	FC
Copper	Unalloyed	< 100	< 350	LC	HC	FC
	Brass, bronze	< 200	< 700	LC	HC	FC
	High strength bronze	< 470	< 1500	HC	LC	FC
Aluminium	Unalloyed	< 100	< 350	LC	HC	FC
	Alloyed, Si < 0.5%	< 150	< 500	LC	HC	FC
	Alloyed, Si < 10%	< 120	< 400	LC	HC	FC
	Alloyed, Si > 10%	< 120	< 400	LC	HC	FC
Inconel	718	< 370		HC	LC	FC
Graphite				LC	HC	FC

## Cutting Speed ( $V_c$ ) and Material Factor ( $F_m$ )

MATERIAL		Hardness HB	Tensile Strength N/mm <sup>2</sup>	Cutting Speed ( $V_c$ ) m/min	Material Factor ( $F_m$ )
Steel	Low carbon, C < 0,25%	< 120	< 400	150 - 200	1,2
	Medium carbon, C < 0,55%	< 200	< 700	120 - 170	1,1
	High carbon, C < 0,85%	< 250	< 850	110 - 150	1,0
	Low alloy	< 250	< 850	100 - 140	1,0
	High alloy	< 350	< 1200	70 - 110	0,9
	Hardened, HRC < 45			60 - 100	0,8
	Hardened, HRC < 55			30 - 60	0,7
Cast iron	Lamellar graphite	< 150	< 500	130 - 180	1,2
	Lamellar graphite	< 300	< 1000	100 - 150	1,1
	Nodular graphite, malleable	< 200	< 700	100 - 150	1,0
Stainless steel	Nodular graphite, malleable	< 300	< 1000	80 - 120	0,9
	Free machining	< 250	< 850	130 - 180	1,0
Titanium	Austenitic	< 250	< 850	90 - 140	0,9
	Ferritic and austenitic	< 300	< 1000	80 - 120	0,8
	Unalloyed	< 200	< 700	60 - 80	0,8
Nickel	Alloyed	< 270	< 900	50 - 70	0,7
	Alloyed	< 350	< 1250	30 - 50	0,6
	Alloyed	< 150	< 500	80 - 120	0,8
Copper	Alloyed	< 270	< 900	60 - 80	0,7
	Alloyed	< 350	< 1250	50 - 70	0,6
	Unalloyed	< 100	< 350	150 - 250	1,0
Aluminium	Brass, bronze	< 200	< 700	130 - 180	1,0
	High strength bronze	< 470	< 1500	60 - 80	0,8
	Unalloyed	< 100	< 350	500 - 900	1,4
	Alloyed, Si < 0.5%	< 150	< 500	400 - 800	1,3
Inconel	Alloyed, Si < 10%	< 120	< 400	300 - 500	1,2
	Alloyed, Si > 10%	< 120	< 400	200 - 400	1,1
	718	< 370		50 - 70	0,6
Graphite			300 - 500	1,0	

## Code Key

### INSERTS

12

insert size

E

E = external  
I = internal  
R = right hand  
L = left hand  
U = U-type

2.0

pitch

ISO

thread profile

HC

carbide grade

### TOOLHOLDERS

S

S = screw

E

E = external  
I = internal

R

R = right hand  
L = left hand

2525

shank dimension

M

holder length

12

insert size

#### Example

2525 = □  
0025 = ○

F = 80 mm    R = 200 mm  
H = 100 mm    S = 250 mm  
K = 125 mm    T = 300 mm  
L = 140 mm    U = 350 mm  
M = 150 mm    V = 400 mm  
P = 170 mm

**Number of Passes**

ISO	Pitch			Material Factor ( $F_m$ )									
	UN	W	NPT	0,6	0,7	0,8	0,9	1,0	1,1	1,2	1,3	1,4	
0,5				7	6	5	4	4	4	4	4	4	
0,75	32	28		8	6	6	5	4	4	4	4	4	
1,0	28-24	19		8	7	6	6	5	5	4	4	4	
1,25	20			9	8	7	6	6	5	5	4	4	
1,5	18-16	14		10	9	8	7	6	5	5	5	4	
1,75	14			12	10	9	8	7	6	6	5	5	
2,0	13-12		27	14	12	11	9	8	8	7	7	6	
2,5	11-10	11	18	16	14	13	11	10	9	8	8	7	
3,0	9-8		14	18	16	14	12	11	10	9	8	8	
3,5	7			20	17	15	13	12	11	10	9	9	
4,0	6		11,5	22	19	16	14	13	12	11	10	9	
4,5				23	20	17	15	14	12	11	10	10	
5,0	5			24	20	18	16	14	13	12	11	10	
5,5	4,5		8	25	21	19	17	15	14	13	12	11	
6,0	4			27	23	20	18	16	15	13	12	11	

**Radial Infeed of Each Pass in %**

PASS	% of the total infeed																
	4	5	6	7	8	9	10	11	12	13	14	15	16	17	18	19	20
1	33	28	25	22	20	19	18	16	14	12	11	11	11	11	10	10	9
2	27	24	20	18	17	16	15	14	13	11	10	10	10	10	10	9	9
3	22	19	17	16	15	14	13	12	11	10	9	9	9	9	9	8	8
4	18	16	15	14	13	12	11	10	9	9	9	8	8	9	8	8	8
5		13	13	12	11	10	9	8	8	8	8	8	8	8	8	7	7
6			10	10	10	9	8	8	8	8	8	7	7	7	7	6	6
7				8	8	8	7	8	8	7	7	7	7	6	6	6	6
8					6	7	7	7	7	7	7	7	6	6	6	6	6
9						5	7	7	7	7	7	6	6	5	6	5	5
10							5	6	6	6	6	6	5	5	5	5	5
11								4	5	6	6	5	5	5	5	5	5
12									4	5	5	5	5	4	4	5	5
13										4	4	4	4	4	4	4	4
14											3	4	4	4	3	4	4
15												3	3	3	3	4	3
16													2	2	2	3	3
17														2	2	2	2
18															2	1,5	2
19																1,5	1,5
20																	1,5

**Threading Methods**

EXTERNAL RIGHT HAND THREAD			
Tool	Anvil	Rotation	Direction
<b>SER</b>	<b>AE +</b>	<b>M03</b>	<b>IN</b>
SER	AE +	M04	OUT
SEL	AI -	M04	OUT
SEL	AI -	M03	IN
INTERNAL RIGHT HAND THREAD			
Tool	Anvil	Rotation	Direction
<b>SIR</b>	<b>AI +</b>	<b>M03</b>	<b>IN</b>
SIL	AE -	M04	OUT

EXTERNAL LEFT HAND THREAD			
Tool	Anvil	Rotation	Direction
<b>SEL</b>	<b>AI +</b>	<b>M04</b>	<b>IN</b>
SEL	AI +	M03	OUT
SER	AE -	M03	OUT
SER	AE -	M04	IN
INTERNAL LEFT HAND THREAD			
Tool	Anvil	Rotation	Direction
<b>SIL</b>	<b>AE +</b>	<b>M04</b>	<b>IN</b>
SIR	AI -	M03	OUT



# THREAD TURNING INSERTS

## FourCut

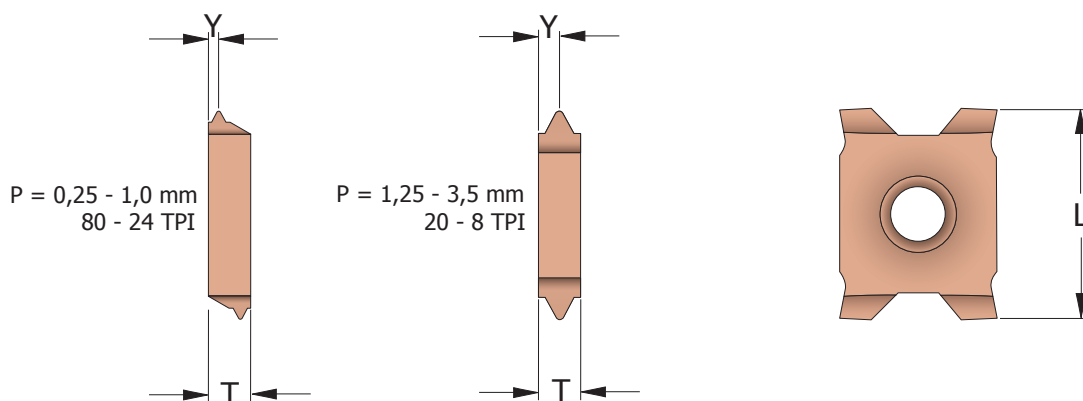

## M

### METRIC

Pitch mm	Part Number EXTERNAL	L mm	T mm	Y mm
0,25	12E_0.25ISO_HC/LC	12	2,4	0,2
0,3	12E_0.3ISO_HC/LC	12	2,4	0,2
0,35	12E_0.35ISO_HC/LC	12	2,4	0,25
0,4	12E_0.4ISO_HC/LC	12	2,4	0,3
0,45	12E_0.45ISO_HC/LC	12	2,4	0,4
0,5	12E_0.5ISO_HC/LC	12	2,4	0,4
0,6	12E_0.6ISO_HC/LC	12	2,4	0,4
0,7	12E_0.7ISO_HC/LC	12	2,4	0,4
0,75	12E_0.75ISO_HC/LC	12	2,4	0,4
0,8	12E_0.8ISO_HC/LC	12	2,4	0,5
1,0	12E_1.0ISO_HC/LC	12	2,4	0,6
1,25	12E_1.25ISO_HC/LC	12	2,4	1,2
1,5	12E_1.5ISO_HC/LC	12	2,4	1,2
1,75	12E_1.75ISO_HC/LC	12	2,4	1,2
2,0	12E_2.0ISO_HC/LC	12	2,4	1,2
2,5	12E_2.5ISO_HC/LC	12	3,6	1,8
3,0	12E_3.0ISO_HC/LC	12	3,6	1,8
3,5	12E_3.5ISO_HC/LC	12	3,6	1,8

## UN

### UNIFIED

Pitch TPI	Part Number EXTERNAL	L mm	T mm	Y mm
80	12E_80UN_HC/LC	12	2,4	0,2
72	12E_72UN_HC/LC	12	2,4	0,25
64	12E_64UN_HC/LC	12	2,4	0,3
56	12E_56UN_HC/LC	12	2,4	0,4
48	12E_48UN_HC/LC	12	2,4	0,4
44	12E_44UN_HC/LC	12	2,4	0,4
40	12E_40UN_HC/LC	12	2,4	0,4
36	12E_36UN_HC/LC	12	2,4	0,4
32	12E_32UN_HC/LC	12	2,4	0,5
28	12E_28UN_HC/LC	12	2,4	0,6
24	12E_24UN_HC/LC	12	2,4	0,6
20	12E_20UN_HC/LC	12	2,4	1,2
18	12E_18UN_HC/LC	12	2,4	1,2
16	12E_16UN_HC/LC	12	2,4	1,2
14	12E_14UN_HC/LC	12	2,4	1,2
13	12E_13UN_HC/LC	12	2,4	1,2
12	12E_12UN_HC/LC	12	2,4	1,2
11	12E_11UN_HC/LC	12	3,6	1,8
10	12E_10UN_HC/LC	12	3,6	1,8
9	12E_9UN_HC/LC	12	3,6	1,8
8	12E_8UN_HC/LC	12	3,6	1,8

# THREAD TURNING INSERTS



## FourCut

### 60°

### PARTIAL PROFILE 60°

Pitch mm	TPI	Part Number EXTERNAL	L mm	T mm	Y mm
0,25 - 1,0	100-24	12E_AAA60_HC/LC	12	2,4	0,6
0,35 - 1,0	72-24	12E_AA60_HC/LC	12	2,4	0,6
0,5 - 2,0	48-12	12E_A60_HC/LC	12	2,4	1,2
0,5 - 3,0	48-8	12E_AG60_HC/LC	12	3,6	1,8
1,75 - 3,0	14-8	12E_G60_HC/LC	12	3,6	1,8

### 55°

### PARTIAL PROFILE 55°

Pitch mm	TPI	Part Number EXTERNAL	L mm	T mm	Y mm
0,35 - 1,0	72-24	12E_AA55_HC/LC	12	2,4	0,6
0,5 - 2,0	48-12	12E_A55_HC/LC	12	2,4	1,2
0,5 - 3,0	48-8	12E_AG55_HC/LC	12	3,6	1,8
1,75 - 3,0	14-8	12E_G55_HC/LC	12	3,6	1,8

### BS/G/Rp

### WHITWORTH PIPE THREAD

Pitch TPI	Part Number EXTERNAL	L mm	T mm	Y mm
28	12E_28W_HC/LC	12	2,4	0,6
24	12E_24W_HC/LC	12	2,4	0,6
20	12E_20W_HC/LC	12	2,4	1,2
19	12E_19W_HC/LC	12	2,4	1,2
18	12E_18W_HC/LC	12	2,4	1,2
16	12E_16W_HC/LC	12	2,4	1,2
14	12E_14W_HC/LC	12	2,4	1,2
12	12E_12W_HC/LC	12	2,4	1,2
11	12E_11W_HC/LC	12	3,6	1,8
10	12E_10W_HC/LC	12	3,6	1,8
9	12E_9W_HC/LC	12	3,6	1,8
8	12E_8W_HC/LC	12	3,6	1,8

### R/Rc

### BSPT PIPE THREAD

Pitch TPI	Part Number EXTERNAL	L mm	T mm	Y mm
28	12E_28BSPT_HC/LC	12	2,4	1,2
19	12E_19BSPT_HC/LC	12	2,4	1,2
14	12E_14BSPT_HC/LC	12	3,6	1,8
11	12E_11BSPT_HC/LC	12	3,6	1,8

### NPT

### NPT PIPE THREAD

Pitch TPI	Part Number EXTERNAL	L mm	T mm	Y mm
27	12E_27NPT_HC/LC	12	2,4	0,6
18	12E_18NPT_HC/LC	12	2,4	1,2
14	12E_14NPT_HC/LC	12	2,4	1,2
11,5	12E_11.5NPT_HC/LC	12	3,6	1,8
8	12E_8NPT_HC/LC	12	3,6	1,8

### NPTF

### NPTF DRYSEAL PIPE THREAD

Pitch TPI	Part Number EXTERNAL	L mm	T mm	Y mm
27	12E_27NPTF_HC/LC	12	2,4	0,6
18	12E_18NPTF_HC/LC	12	2,4	1,2
14	12E_14NPTF_HC/LC	12	2,4	1,2
11,5	12E_11.5NPTF_HC/LC	12	3,6	1,8
8	12E_8NPTF_HC/LC	12	3,6	1,8

All inserts have ground profile and chipbreaker. Choose grade between HC and LC. [See page 43.](#)

# THREAD TURNING INSERTS

## FourCut

### PG

#### STEEL CONDUIT THREAD DIN 40430

Pitch TPI	Part Number EXTERNAL	L mm	T mm	Y mm
20	12E_20PG_HC/LC	12	2,4	1,2
18	12E_18PG_HC/LC	12	2,4	1,2
16	12E_16PG_HC/LC	12	2,4	1,2

### TR

#### TRAPEZ DIN 103

Pitch mm	Part Number EXTERNAL	L mm	T mm	Y mm
1,5	12E_1.5TR_HC/LC	12	2,4	1,2
2,0	12E_2.0TR_HC/LC	12	2,4	1,2
3,0	12E_3.0TR_HC/LC	12	2,4	1,2
4,0	12E_4.0TR_HC/LC	12	3,6	1,8

### RD

#### ROUND DIN 405

Pitch TPI	Part Number EXTERNAL	L mm	T mm	Y mm
10	12E_10RD_HC/LC	12	3,6	1,8
8	12E_8RD_HC/LC	12	3,6	1,8

### ACME

#### ACME

Pitch TPI	Part Number EXTERNAL	L mm	T mm	Y mm
16	12E_16ACME_HC/LC	12	2,4	1,2
14	12E_14ACME_HC/LC	12	2,4	1,2
12	12E_12ACME_HC/LC	12	2,4	1,2
10	12E_10ACME_HC/LC	12	2,4	1,2
8	12E_8ACME_HC/LC	12	2,4	1,2
6	12E_6ACME_HC/LC	12	3,6	1,8

### STACME

#### STUB ACME

Pitch TPI	Part Number EXTERNAL	L mm	T mm	Y mm
16	12E_16STACME_HC/LC	12	2,4	1,2
14	12E_14STACME_HC/LC	12	2,4	1,2
12	12E_12STACME_HC/LC	12	2,4	1,2
10	12E_10STACME_HC/LC	12	2,4	1,2
8	12E_8STACME_HC/LC	12	2,4	1,2
6	12E_6STACME_HC/LC	12	3,6	1,8
5	12E_5STACME_HC/LC	12	3,6	1,8

### MJ

#### METRIC

Pitch mm	Part Number EXTERNAL	L mm	T mm	Y mm
1,0	12E_1.0MJ_HC/LC	12	2,4	0,6
1,5	12E_1.5MJ_HC/LC	12	2,4	1,2
2,0	12E_2.0MJ_HC/LC	12	3,6	1,8

■ All inserts have ground profile and chipbreaker. Choose grade between HC and LC. [See page 43.](#)

# THREAD TURNING INSERTS

## FourCut Multitooth

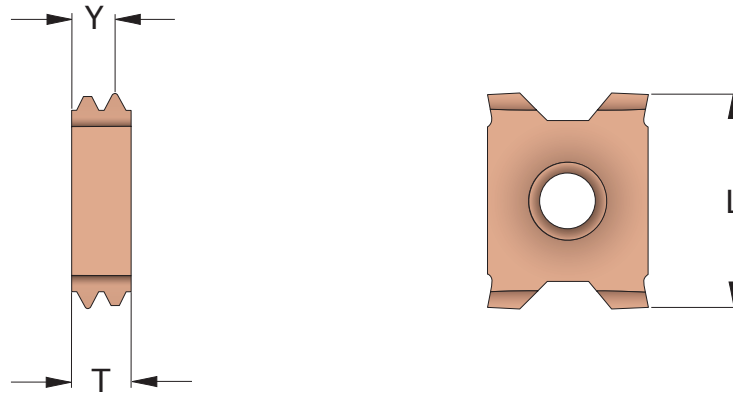

### M

### METRIC

Pitch mm	Part Number EXTERNAL	L mm	T mm	Y mm	Radial infeed per pass		
					1	2	3
1,0	12ER_1.0ISO2M <sub>HC/LC</sub>	12	2,4	1,7	0,24	0,21	0,18
1,5	12ER_1.5ISO2M <sub>HC/LC</sub>	12	3,6	2,55	0,43	0,30	0,21
2,0	12ER_2.0ISO2M <sub>HC/LC</sub>	12	3,6	2,8	0,57	0,40	0,28

### G/Rp

### WHITWORTH PIPE THREAD

Pitch TPI	Part Number EXTERNAL	L mm	T mm	Y mm	Radial infeed per pass		
					1	2	3
14	12ER_14W2M <sub>HC/LC</sub>	12	3,6	2,7	0,55	0,38	0,25

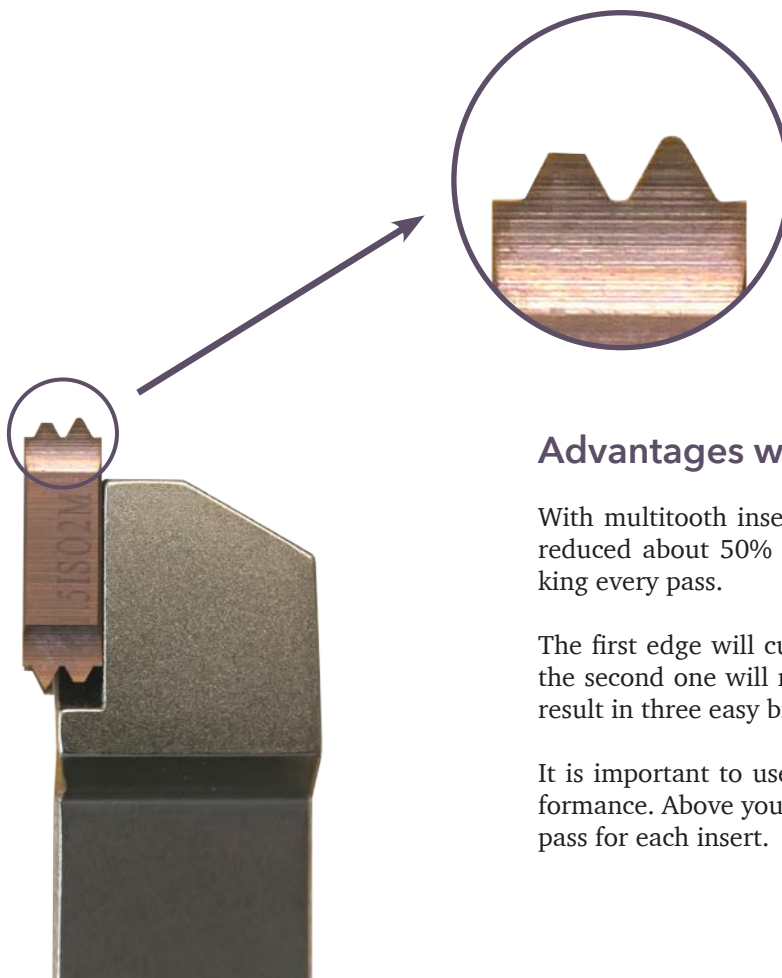

### Advantages with Multitooth Inserts

With multitooth inserts the machining time can be reduced about 50% as two cutting edges are working every pass.

The first edge will cut the flanks of the thread and the second one will make the root radius. This will result in three easy breakable chips.

It is important to use radial infeed to get best performance. Above you have recommended infeed per pass for each insert.

# GROOVING INSERTS

## FourCut

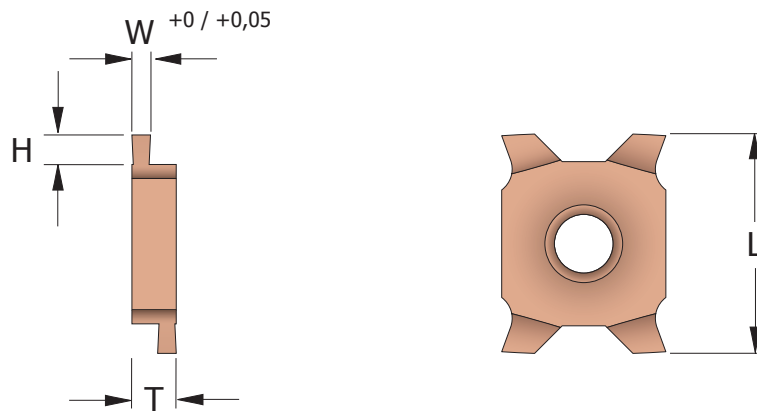

## SQ

## GROOVING

W +0 / +0,05	EXTERNAL Part Number	L mm	T mm	H mm
0,4	12ER_0.4SQ_HC/LC	12	2,4	0,8
0,5	12ER_0.5SQ_HC/LC	12	2,4	1,0
0,6	12ER_0.6SQ_HC/LC	12	2,4	1,2
0,7	12ER_0.7SQ_HC/LC	12	2,4	1,4
0,8	12ER_0.8SQ_HC/LC	12	2,4	1,6
0,9	12ER_0.9SQ_HC/LC	12	2,4	1,8
1,0	12ER_1.0SQ_HC/LC	12	2,4	2,0
1,1	12ER_1.1SQ_HC/LC	12	2,4	2,0
1,2	12ER_1.2SQ_HC/LC	12	2,4	2,0
1,3	12ER_1.3SQ_HC/LC	12	2,4	2,0
1,4	12ER_1.4SQ_HC/LC	12	2,4	2,0
1,5	12ER_1.5SQ_HC/LC	12	2,4	2,0
1,6	12ER_1.6SQ_HC/LC	12	2,4	2,0
1,7	12ER_1.7SQ_HC/LC	12	2,4	2,0
1,85	12ER_1.85SQ_HC/LC	12	2,4	2,0
2,0	12ER_2.0SQ_HC/LC	12	2,4	2,0
2,15	12ER_2.15SQ_HC/LC	12	2,4	2,0
2,3	12ER_2.3SQ_HC/LC	12	2,4	2,0
2,5	12ER_2.5SQ_HC/LC	12	3,6	2,0
2,65	12ER_2.65SQ_HC/LC	12	3,6	2,0
2,8	12ER_2.8SQ_HC/LC	12	3,6	2,0
3	12ER_3.0SQ_HC/LC	12	3,6	2,0
3,15	12ER_3.15SQ_HC/LC	12	3,6	2,0
3,3	12ER_3.3SQ_HC/LC	12	3,6	2,0
3,5	12ER_3.5SQ_HC/LC	12	3,6	2,0

■ All inserts have ground profile and chipbreaker. Choose grade between HC and LC. [See page 43.](#)

## Maximum Grooving Diameter

You are not able to use the maximum grooving depth when the diameter is bigger then  $D_{max}$  as the cutting edge below will touch the part.

H mm	$D_{max}$ mm
2,0	70
1,9	80
1,8	93
1,7	111
1,6	139
1,5	185

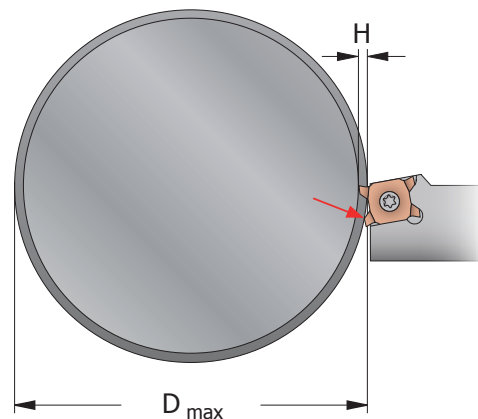

# THREADING AND GROOVING INSERTS

## Kits with Different Inserts

### Threading Inserts Kits

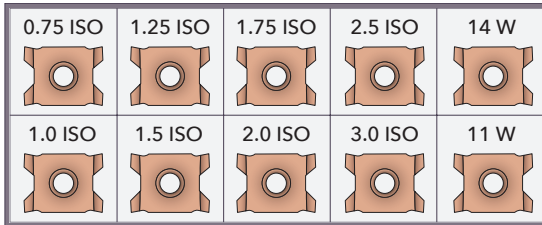

Part Number
10X12E_HC

■ 10 different inserts in one box.

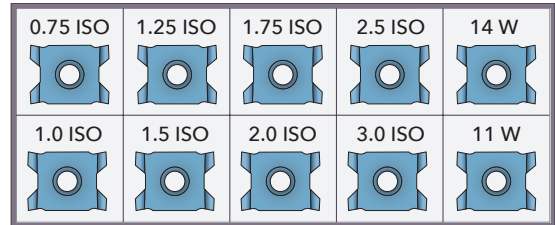

Part Number
10X12E_LC

■ 10 different inserts in one box.

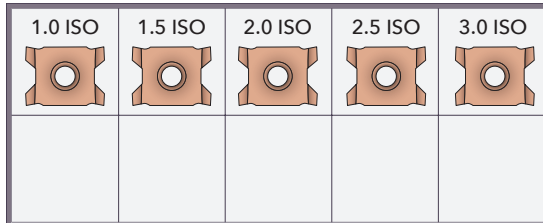

Part Number
5X12E_HC

■ 5 different inserts in one box.

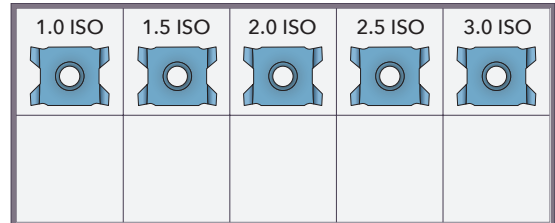

Part Number
5X12E_LC

■ 5 different inserts in one box.

### Grooving Inserts Kits

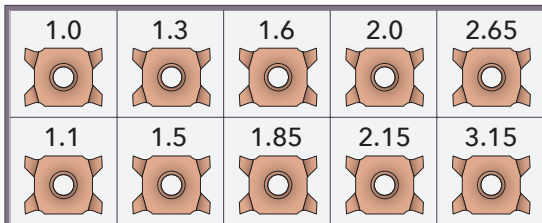

Part Number
10X12SQ_HC

■ 10 different inserts in one box.

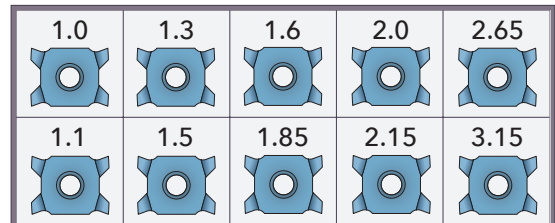

Part Number
10X12SQ_LC

■ 10 different inserts in one box.



*FourCut uses the same toolholder for grooving and threading.*

# THREAD TURNING TOOLHOLDERS

## FourCut External

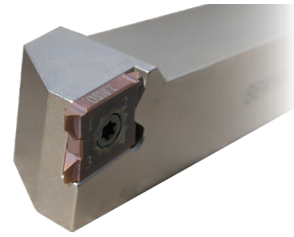
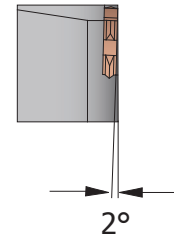
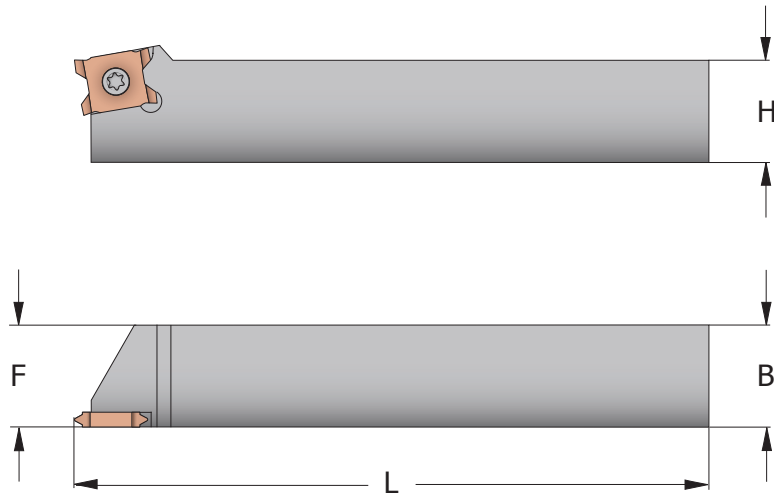

Insert mm	Part Number	B/H mm	L mm	F mm
12	SER0808H12	8	100	8
12	SER1010H12	10	100	10
12	SER1212H12	12	100	12
12	SER1616H12	16	100	16
12	SER2020K12	20	125	20
12	SER2525M12	25	150	25
12	SER3232P12	32	170	32

■ The Part Numbers are for Right Hand Toolholders. For Left Hand specify L instead of R. The Price is 10% higher for L.

## with Internal Coolant

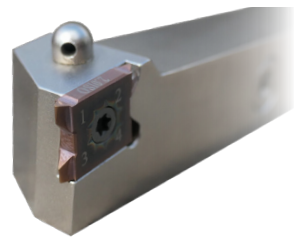
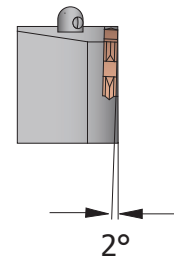
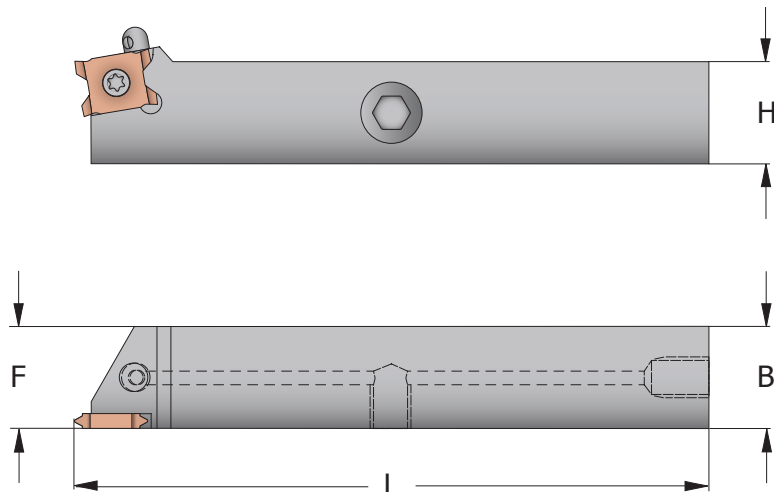

Insert mm	Part Number	B/H mm	L mm	F mm	PLUG
12	SER1212H12-J*	12	100	12	M8x1
12	SER1616H12-J	16	100	16	G1/8
12	SER2020K12-J	20	125	20	G1/8
12	SER2525M12-J	25	150	25	G1/8

\* This toolholder also has a plug on the backside, totally three plugs.



# THREAD TURNING TOOLHOLDERS

with Extra Accessibility

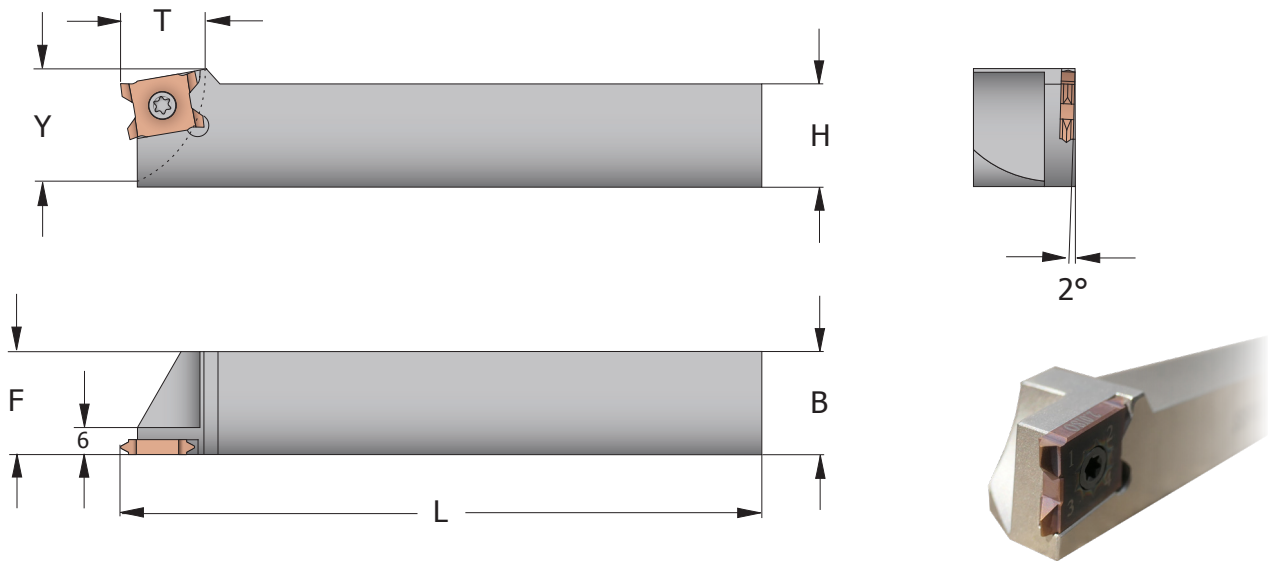

Insert mm	Part Number	B/H mm	L mm	F mm	T mm	Y mm
12	SER1212T09H12	12	100	12	9	11,0
12	SER1616T11H12	16	100	16	11	14,7
12	SER2020T14K12	20	125	20	14	18,7
12	SER2525T18M12	25	150	25	18	23,8

## Maximum Allowable Access

When you are working between shoulders there is a limit of the accessibility which depends on the toolholder and the diameters of the workpiece.

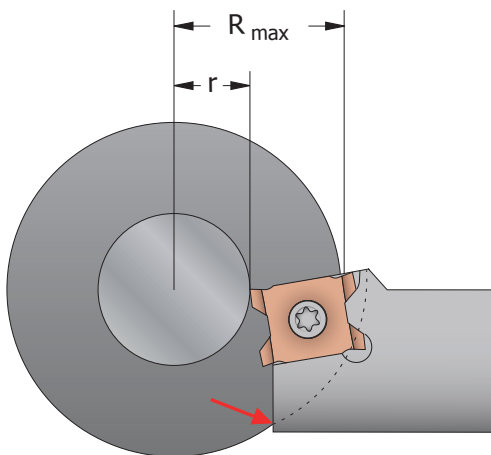

$$R_{\max} = \sqrt{(r + 2,5)^2 + Y^2}$$

$$T = R - r$$

You should never exceed the calculated  $R_{\max}$  or the T dimension of the toolholder. If you need better accessibility you have to modify the holder.

For diagram of accessibility go to [smicut.com/acc](http://smicut.com/acc)



## Spare Parts

Insert mm	Screw to insert	Torx key
12	T9XM3	TORX_T9

# THREAD TURNING INSERTS

## Triangular

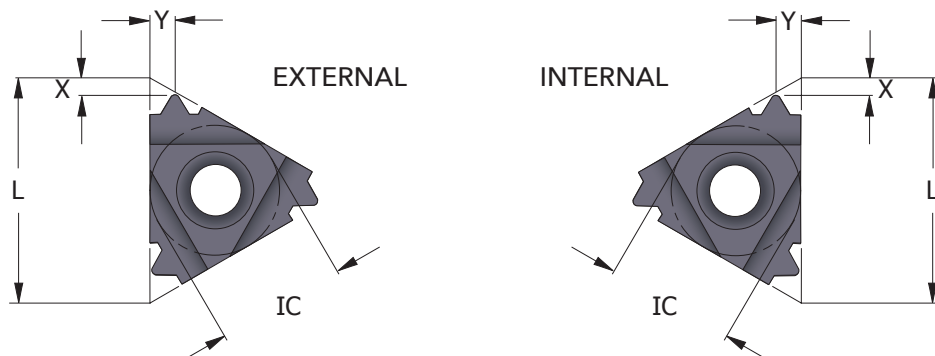

### M

### METRIC

Pitch mm	L mm	IC inch	EXTERNAL Part Number	X mm	Y mm	INTERNAL Part Number	X mm	Y mm
0,5	6	5/32				06IR_0.5ISO_BC	0,9	0,5
0,5	16	3/8	16ER_0.5ISO_FC	0,6	0,6			
0,7	16	3/8	16ER_0.7ISO_FC	0,6	0,6			
0,75	6	5/32				06IR_0.75ISO_BC	0,8	0,5
0,75	8	3/16				08IR_0.75ISO_BC	0,6	0,5
0,75	16	3/8	16ER_0.75ISO_FC	0,6	0,6			
0,8	16	3/8	16ER_0.8ISO_FC	0,6	0,6			
1,0	6	5/32				06IR_1.0ISO_BC	0,7	0,6
1,0	8	3/16				08IR_1.0ISO_BC	0,6	0,6
1,0	11	1/4				11IR_1.0ISO_FC	0,6	0,7
1,0	16	3/8	16ER_1.0ISO_FC	0,7	0,7	16IR_1.0ISO_FC	0,6	0,7
1,25	6	5/32				06IR_1.25ISO_BC	0,6	0,6
1,25	8	3/16				08IR_1.25ISO_BC	0,6	0,7
1,25	11	1/4				11IR_1.25ISO_FC	0,8	0,8
1,25	16	3/8	16ER_1.25ISO_FC	0,8	0,9	16IR_1.25ISO_FC	0,8	0,9
1,5	8	3/16				08IR_1.5ISO_BC	0,6	0,7
1,5	11	1/4				11IR_1.5ISO_FC	0,8	1,0
1,5	16	3/8	16ER_1.5ISO_FC	0,8	1,0	16IR_1.5ISO_FC	0,8	1,0
1,75	8	3/16				08IR_1.75ISO_BC	1,0	0,8
1,75	16	3/8	16ER_1.75ISO_FC	0,9	1,2	16IR_1.75ISO_FC	0,9	1,2
2,0	11	1/4				11IR_2.0ISO_FC	0,8	0,9
2,0	16	3/8	16ER_2.0ISO_FC	1,0	1,3	16IR_2.0ISO_FC	1,0	1,3
2,5	16	3/8	16ER_2.5ISO_FC	1,1	1,5	16IR_2.5ISO_FC	1,1	1,5
3,0	16	3/8	16ER_3.0ISO_FC	1,2	1,6	16IR_3.0ISO_FC	1,1	1,5
3,5	16	3/8	16ER_3.5ISO_FC	1,2	1,7	16IR_3.5ISO_FC	1,2	1,7
3,5	22	1/2	22ER_3.5ISO_FC	1,6	2,3	22IR_3.5ISO_FC	1,6	2,3
4,0	22	1/2	22ER_4.0ISO_FC	1,6	2,3	22IR_4.0ISO_FC	1,6	2,3
4,5	22	1/2	22ER_4.5ISO_FC	1,7	2,4	22IR_4.5ISO_FC	1,6	2,4
5,0	22	1/2	22ER_5.0ISO_FC	1,7	2,5	22IR_5.0ISO_FC	1,6	2,3
5,5	22	1/2	22ER_5.5ISO_FC	1,7	2,6	22IR_5.5ISO_FC	1,6	2,3
5,5	27	5/8	27ER_5.5ISO_FC	1,9	2,7	27IR_5.5ISO_FC	1,6	2,3
6,0	22	1/2	22ER_6.0ISO_FC	1,9	2,7	22IR_6.0ISO_FC	1,6	2,4
6,0	27	5/8	27ER_6.0ISO_FC	2,0	2,9	27IR_6.0ISO_FC	1,8	2,5
<b>WITH SINTERED CHIPBREAKER</b>								
1,0	16	3/8	16ER_1.0ISO CB_FC	0,7	0,7	16IR_1.0ISO CB_FC	0,6	0,7
1,25	16	3/8	16ER_1.25ISO CB_FC	0,8	0,9			
1,5	16	3/8	16ER_1.5ISO CB_FC	0,8	1,0	16IR_1.5ISO CB_FC	0,8	1,0
1,75	16	3/8	16ER_1.75ISO CB_FC	0,9	1,2			
2,0	16	3/8	16ER_2.0ISO CB_FC	1,0	1,3	16IR_2.0ISO CB_FC	1,0	1,3
2,5	16	3/8	16ER_2.5ISO CB_FC	1,1	1,5	16IR_2.5ISO CB_FC	1,1	1,5
3,0	16	3/8	16ER_3.0ISO CB_FC	1,2	1,6	16IR_3.0ISO CB_FC	1,1	1,5

# THREAD TURNING INSERTS

## UN

## UNIFIED

Pitch TPI	L mm	IC inch	EXTERNAL Part Number	X mm	Y mm	INTERNAL Part Number	X mm	Y mm
32	6	5/32				06IR_32UN_BC	0,8	0,5
32	8	3/16				08IR_32UN_BC	0,6	0,5
32	11	1/4				11IR_32UN_FC	0,6	0,6
32	16	3/8	16ER_32UN_FC	0,6	0,6	16IR_32UN_FC	0,6	0,6
28	6	5/32				06IR_28UN_BC	0,8	0,6
28	8	3/16				08IR_28UN_BC	0,6	0,6
28	11	1/4				11IR_28UN_FC	0,6	0,7
28	16	3/8	16ER_28UN_FC	0,6	0,7	16IR_28UN_FC	0,6	0,7
24	6	5/32				06IR_24UN_BC	0,7	0,6
24	8	3/16				08IR_24UN_BC	0,6	0,6
24	11	1/4				11IR_24UN_FC	0,7	0,8
24	16	3/8	16ER_24UN_FC	0,7	0,8			
20	6	5/32				06IR_20UN_BC	0,6	0,6
20	8	3/16				08IR_20UN_BC	0,6	0,7
20	11	1/4				11IR_20UN_FC	0,8	0,9
20	16	3/8	16ER_20UN_FC	0,8	0,9	16IR_20UN_FC	0,8	0,9
18	6	5/32				06IR_18UN_BC	0,6	0,7
18	11	1/4				11IR_18UN_FC	0,8	1,0
18	16	3/8	16ER_18UN_FC	0,8	1,0			
16	8	3/16				08IR_16UN_BC	0,6	0,7
16	11	1/4				11IR_16UN_FC	0,9	1,1
16	16	3/8	16ER_16UN_FC	0,9	1,1	16IR_16UN_FC	0,9	1,1
14	8	3/16				08IR_14UN_BC	0,6	0,8
14	16	3/8	16ER_14UN_FC	1,0	1,2	16IR_14UN_FC	0,9	1,2
13	16	3/8	16ER_13UN_FC	1,0	1,3			
12	11	1/4				11IR_12UN_FC	0,9	1,1
12	16	3/8	16ER_12UN_FC	1,1	1,4	16IR_12UN_FC	1,1	1,4
11	11	1/4				11IR_11UN_FC	0,8	1,1
11	16	3/8	16ER_11UN_FC	1,1	1,5			
10	16	3/8	16ER_10UN_FC	1,1	1,5	16IR_10UN_FC	1,1	1,5
9	16	3/8	16ER_9UN_FC	1,2	1,7	16IR_9UN_FC	1,2	1,7
8	16	3/8	16ER_8UN_FC	1,2	1,6	16IR_8UN_FC	1,1	1,5
7	22	1/2	22ER_7UN_FC	1,6	2,3	22IR_7UN_FC	1,6	2,3
6	22	1/2	22ER_6UN_FC	1,6	2,3	22IR_6UN_FC	1,6	2,3
5	22	1/2	22ER_5UN_FC	1,7	2,5	22IR_5UN_FC	1,6	2,3
4,5	27	5/8	27ER_4.5UN_FC	1,9	2,7	27IR_4.5UN_FC	1,7	2,4
4	27	5/8	27ER_4UN_FC	2,1	3,0	27IR_4UN_FC	1,8	2,7

- The Part Numbers are for Right Hand Inserts. For Left Hand specify L instead of R. The Price is 10% higher for L.
- All inserts have ground profile and chipbreaker if nothing else is indicated.

# THREAD TURNING INSERTS

## 60°

### PARTIAL PROFILE 60°

Pitch mm	TPI	L mm	IC inch	EXTERNAL Part Number	INTERNAL Part Number	X mm	Y mm
0,5-1,25	48-20	6	5/32		06IR_A60_BC	0,6	0,6
0,5-1,5	48-16	8	3/16		08IR_A60_BC	0,6	0,7
0,5-1,5	48-16	11	1/4		11IR_A60_FC	0,8	0,9
0,5-1,5	48-16	16	3/8	16ER_A60_FC	16IR_A60_FC	0,8	0,9
1,75-3,0	14-8	16	3/8	16ER_G60_FC	16IR_G60_FC	1,2	1,7
0,5-3,0	48-8	16	3/8	16ER_AG60_FC	16IR_AG60_FC	1,2	1,7
3,5-5,0	7-5	22	1/2	22ER_N60_FC	22IR_N60_FC	1,7	2,5
5,5-6,0	4,5-4	27	5/8	27ER_Q60_FC	27IR_Q60_FC	2,1	3,1

## 55°

### PARTIAL PROFILE 55°

Pitch mm	TPI	L mm	IC inch	EXTERNAL Part Number	INTERNAL Part Number	X mm	Y mm
0,5-1,25	48-20	6	5/32		06IR_A55_BC	0,5	0,6
0,5-1,5	48-16	8	3/16		08IR_A55_BC	0,6	0,7
0,5-1,5	48-16	11	1/4		11IR_A55_FC	0,8	0,9
0,5-1,5	48-16	16	3/8	16ER_A55_FC	16IR_A55_FC	0,8	0,9
1,75-3,0	14-8	16	3/8	16ER_G55_FC	16IR_G55_FC	1,2	1,7
0,5-3,0	48-8	16	3/8	16ER_AG55_FC	16IR_AG55_FC	1,2	1,7
3,5-5,0	7-5	22	1/2	22ER_N55_FC	22IR_N55_FC	1,7	2,5
5,5-6,0	4,5-4	27	5/8	27ER_Q55_FC	27IR_Q55_FC	2,0	2,9

## MJ

### METRIC

Pitch mm	L mm	IC inch	EXTERNAL Part Number	X mm	Y mm	INTERNAL Part Number	X mm	Y mm
1,0	11	1/4				11IR_1.0MJ_FC	0,6	0,7
1,0	16	3/8	16ER_1.0MJ_FC	0,7	0,7	16IR_1.0MJ_FC	0,6	0,7
1,25	11	1/4				11IR_1.25MJ_FC	0,8	0,8
1,25	16	3/8	16ER_1.25MJ_FC	0,8	0,9	16IR_1.25MJ_FC	0,8	0,9
1,5	11	1/4				11IR_1.5MJ_FC	0,8	1,0
1,5	16	3/8	16ER_1.5MJ_FC	0,8	1,0	16IR_1.5MJ_FC	0,8	1,0
2,0	11	1/4				11IR_2.0MJ_FC	0,8	0,9
2,0	16	3/8	16ER_2.0MJ_FC	1,0	1,3	16IR_2.0MJ_FC	1,0	1,3

## UNJ

### UNIFIED

Pitch TPI	L mm	IC inch	EXTERNAL Part Number	X mm	Y mm	INTERNAL Part Number	X mm	Y mm
32	11	1/4				11IR_32UNJ_FC	0,6	0,6
32	16	3/8	16ER_32UNJ_FC	0,6	0,6	16IR_32UNJ_FC	0,6	0,6
28	11	1/4				11IR_28UNJ_FC	0,6	0,7
28	16	3/8	16ER_28UNJ_FC	0,6	0,7	16IR_28UNJ_FC	0,6	0,7
24	11	1/4				11IR_24UNJ_FC	0,7	0,8
24	16	3/8	16ER_24UNJ_FC	0,7	0,8			
20	11	1/4				11IR_20UNJ_FC	0,8	0,9
20	16	3/8	16ER_20UNJ_FC	0,8	0,9	16IR_20UNJ_FC	0,8	0,9
18	11	1/4				11IR_18UNJ_FC	0,8	1,0
18	16	3/8	16ER_18UNJ_FC	0,8	1,0			
16	11	1/4				11IR_16UNJ_FC	0,9	1,1
16	16	3/8	16ER_16UNJ_FC	0,9	1,1	16IR_16UNJ_FC	0,9	1,1
14	16	3/8	16ER_14UNJ_FC	1,0	1,2	16IR_14UNJ_FC	0,9	1,2
13	16	3/8	16ER_13UNJ_FC	1,0	1,3			
12	16	3/8	16ER_12UNJ_FC	1,1	1,4	16IR_12UNJ_FC	1,1	1,4
11	16	3/8	16ER_11UNJ_FC	1,1	1,5			
10	16	3/8	16ER_10UNJ_FC	1,1	1,5	16IR_10UNJ_FC	1,1	1,5
9	16	3/8	16ER_9UNJ_FC	1,2	1,7	16IR_9UNJ_FC	1,2	1,7
8	16	3/8	16ER_8UNJ_FC	1,2	1,6	16IR_8UNJ_FC	1,1	1,5

# THREAD TURNING INSERTS



## BS/G/Rp

## WHITWORTH

Pitch TPI	L mm	IC inch	EXTERNAL Part Number	X mm	Y mm	INTERNAL Part Number	X mm	Y mm
32	16	3/8	16ER_32W_FC	0,6	0,6			
28	6	5/32				06IR_28W_BC	0,6	0,6
28	8	3/16				08IR_28W_BC	0,6	0,6
28	16	3/8	16ER_28W_FC	0,6	0,7			
26	6	5/32				06IR_26W_BC	0,7	0,6
26	16	3/8	16ER_26W_FC	0,7	0,7			
24	16	3/8	16ER_24W_FC	0,7	0,8			
22	06	5/32				06IR_22W_BC	0,6	0,6
22	16	3/8	16ER_22W_FC	0,8	0,9			
20	08	3/16				08IR_20W_BC	0,6	0,7
20	16	3/8	16ER_20W_FC	0,8	0,9	16IR_20W_FC	0,8	0,9
19	8	3/16				08IR_19W_BC	0,6	0,7
19	11	1/4				11IR_19W_FC	0,8	1,0
19	16	3/8	16ER_19W_FC	0,8	1,0	16IR_19W_FC	0,8	1,0
18	08	3/16				08IR_18W_BC	0,6	0,7
18	16	3/8	16ER_18W_FC	0,8	1,0	16IR_18W_FC	0,8	1,0
16	08	3/16				08IR_16W_BC	0,6	0,7
16	16	3/8	16ER_16W_FC	0,9	1,1	16IR_16W_FC	0,9	1,1
14	11	1/4				11IR_14W_FC	0,9	1,1
14	16	3/8	16ER_14W_FC	1,0	1,2	16IR_14W_FC	1,0	1,2
12	11	1/4				11IR_12W_FC	0,1	1,1
12	16	3/8	16ER_12W_FC	1,1	1,4	16IR_12W_FC	1,1	1,4
11	16	3/8	16ER_11W_FC	1,1	1,5	16IR_11W_FC	1,1	1,5
10	16	3/8	16ER_10W_FC	1,1	1,5	16IR_10W_FC	1,1	1,5
9	16	3/8	16ER_9W_FC	1,2	1,7	16IR_9W_FC	1,2	1,7
8	16	3/8	16ER_8W_FC	1,2	1,5	16IR_8W_FC	1,2	1,5
7	22	1/2	22ER_7W_FC	1,6	2,3	22IR_7W_FC	1,6	2,3
6	22	1/2	22ER_6W_FC	1,6	2,3	22IR_6W_FC	1,6	2,3
5	22	1/2	22ER_5W_FC	1,7	2,4	22IR_5W_FC	1,7	2,4
4,5	27	5/8	27ER_4.5W_FC	1,8	2,6	27IR_4.5W_FC	1,8	2,6
4	27	5/8	27ER_4W_FC	2,0	2,9	27IR_4W_FC	2,0	2,9
<b>WITH SINTERED CHIPBREAKER</b>								
19	16	3/8	16ER_19WCB_FC	0,8	1,0			
14	16	3/8	16ER_14WCB_FC	1,0	1,2	16IR_14WCB_FC	1,0	1,2
11	16	3/8	16ER_11WCB_FC	1,1	1,5	16IR_11WCB_FC	1,1	1,5

## R/Rc

## BSPT PIPE THREAD

Pitch TPI	L mm	IC inch	EXTERNAL Part Number	X mm	Y mm	INTERNAL Part Number	X mm	Y mm
28	6	5/32				06IR_28BSPT_BC	0,7	0,6
28	16	3/8	16ER_28BSPT_FC	0,6	0,6			
19	8	3/16				08IR_19BSPT_BC	0,6	0,6
19	16	3/8	16ER_19BSPT_FC	0,8	0,9			
14	16	3/8	16ER_14BSPT_FC	1,0	1,2	16IR_14BSPT_FC	1,0	1,2
11	16	3/8	16ER_11BSPT_FC	1,1	1,5	16IR_11BSPT_FC	1,1	1,5

- The Part Numbers are for Right Hand Inserts. For Left Hand specify L instead of R. The Price is 10% higher for L.
- All inserts have ground profile and chipbreaker if nothing else is indicated.

# THREAD TURNING INSERTS

## NPT

### NPT PIPE THREAD

Pitch TPI	L mm	IC inch	EXTERNAL Part Number	X mm	Y mm	INTERNAL Part Number	X mm	Y mm
27	6	5/32				06IR_27NPT_BC	0,6	0,6
27	8	3/16				08IR_27NPT_BC	0,6	0,6
27	16	3/8	16ER_27NPT_FC	0,7	0,8			
18	8	3/16				08IR_18NPT_BC	0,6	0,6
18	11	1/4				11IR_18NPT_FC	0,8	1,0
18	16	3/8	16ER_18NPT_FC	0,8	1,0			
14	16	3/8	16ER_14NPT_FC	0,9	1,2	16IR_14NPT_FC	0,9	1,2
11,5	16	3/8	16ER_11.5NPT_FC	1,1	1,5	16IR_11.5NPT_FC	1,1	1,5
8	16	3/8	16ER_8NPT_FC	1,3	1,8	16IR_8NPT_FC	1,3	1,8

## NPTF

### NPTF DRYSEAL PIPE THREAD

Pitch TPI	L mm	IC inch	EXTERNAL Part Number	X mm	Y mm	INTERNAL Part Number	X mm	Y mm
27	6	5/32				06IR_27NPTF_BC	0,7	0,6
27	8	3/16				08IR_27NPTF_BC	0,6	0,6
27	16	3/8	16ER_27NPTF_FC	0,7	0,7			
18	8	3/16				08IR_18NPTF_BC	0,6	0,6
18	11	1/4				11IR_18NPTF_FC	0,8	1,0
18	16	3/8	16ER_18NPTF_FC	0,8	1,0			
14	16	3/8	16ER_14NPTF_FC	0,9	1,2	16IR_14NPTF_FC	0,9	1,2
11,5	16	3/8	16ER_11.5NPTF_FC	1,1	1,5	16IR_11.5NPTF_FC	1,1	1,5
8	16	3/8	16ER_8NPTF_FC	1,3	1,8	16IR_8NPTF_FC	1,3	1,8

## ABUT

### AMERICAN BUTTRESS

Pitch TPI	L mm	IC inch	EXTERNAL Part Number	X mm	Y mm	INTERNAL Part Number	X mm	Y mm
20	11	1/4				11IR_20ABUT_FC	1,0	1,3
16	11	1/4				11IR_16ABUT_FC	1,0	1,5
20	16	3/8	16ER_20ABUT_FC	1,0	1,3	16IR_20ABUT_FC	1,0	1,3
16	16	3/8	16ER_16ABUT_FC	1,0	1,5	16IR_16ABUT_FC	1,0	1,5
12	16	3/8	16ER_12ABUT_FC	1,4	2,0	16IR_12ABUT_FC	1,4	2,0
10	16	3/8	16ER_10ABUT_FC	1,5	2,3	16IR_10ABUT_FC	1,5	2,3
8	22	1/2	22ER_8ABUT_FC	2,1	3,3	22IR_8ABUT_FC	2,1	3,3
6	22	1/2	22ER_6ABUT_FC	2,1	3,4	22IR_6ABUT_FC	2,1	3,4

## SG

### BUTTRESS (SÄGENGEWINDE) DIN 513/514

Pitch mm	L mm	IC inch	EXTERNAL Part Number	X mm	Y mm	INTERNAL Part Number	X mm	Y mm
2,0	16	3/8	16ER_2.0SG_FC	1,1	1,6	16IR_2.0SG_FC	1,2	1,7
3,0	22	3/8	22ER_3.0SG_FC	1,5	2,4	22IR_3.0SG_FC	1,9	2,9
4,0	22	1/2	22ER_4.0SG_FC	1,9	3,1	22IR_4.0SG_FC	2,3	3,5

## PG

### STEEL CONDUIT THREAD DIN 40430

Pitch TPI	L mm	IC inch	EXTERNAL Part Number	X mm	Y mm	INTERNAL Part Number	X mm	Y mm
20	8	3/16				08IR_20PG_BC	0,6	0,7
18	11	1/4				11IR_18PG_FC	0,8	0,9
20	16	3/8	16ER_20PG_FC	0,7	0,8			
18	16	3/8	16ER_18PG_FC	0,8	0,9	16IR_18PG_FC	0,8	0,9
16	16	3/8	16ER_16PG_FC	0,8	1,0	16IR_16PG_FC	0,8	1,0

# THREAD TURNING INSERTS



## TR

### TRAPEZ DIN 103

Pitch mm	L mm	IC inch	EXTERNAL Part Number	X mm	Y mm	INTERNAL Part Number	X mm	Y mm
1,5	16	3/8	16ER_1.5TR_FC	1,0	1,1			
2,0	16	3/8	16ER_2.0TR_FC	1,0	1,3	16IR_2.0TR_FC	1,0	1,3
3,0	16	3/8	16ER_3.0TR_FC	1,3	1,5	16IR_3.0TR_FC	1,3	1,5
4,0	22	1/2	22ER_4.0TR_FC	1,8	1,9	22IR_4.0TR_FC	1,8	1,9
5,0	22	1/2	22ER_5.0TR_FC	2,0	2,4	22IR_5.0TR_FC	2,0	2,4
6,0	22	1/2	22ER_6.0TR_FC	2,0	2,4	22IR_6.0TR_FC	2,0	2,4
6,0	27	5/8	27ER_6.0TR_FC	2,3	2,7	27IR_6.0TR_FC	2,3	2,7
7,0	27	5/8	27ER_7.0TR_FC	2,2	2,6	27IR_7.0TR_FC	2,2	2,6

## RD

### ROUND DIN 405

Pitch TPI	L mm	IC inch	EXTERNAL Part Number	X mm	Y mm	INTERNAL Part Number	X mm	Y mm
10	16	3/8	16ER_10RD_FC	1,1	1,2	16IR_10RD_FC	1,1	1,2
8	16	3/8	16ER_8RD_FC	1,4	1,3	16IR_8RD_FC	1,4	1,4
6	16	3/8	16ER_6RD_FC	1,5	1,7	16IR_6RD_FC	1,4	1,5
6	22	1/2	22ER_6RD_FC	1,5	1,7	22IR_6RD_FC	1,5	1,7
4	22	1/2	22ER_4RD_FC	2,2	2,3	22IR_4RD_FC	2,2	2,3
4	27	5/8	27ER_4RD_FC	2,2	2,3	27IR_4RD_FC	2,2	2,3

## ACME

### ACME

Pitch TPI	L mm	IC inch	EXTERNAL Part Number	X mm	Y mm	INTERNAL Part Number	X mm	Y mm
16	11	1/4				11IR_16ACME_FC	0,9	1,0
16	16	3/8	16ER_16ACME_FC	0,9	1,0	16IR_16ACME_FC	0,9	1,0
14	16	3/8	16ER_14ACME_FC	1,0	1,2	16IR_14ACME_FC	1,0	1,2
12	16	3/8	16ER_12ACME_FC	1,1	1,2	16IR_12ACME_FC	1,1	1,2
10	16	3/8	16ER_10ACME_FC	1,3	1,3	16IR_10ACME_FC	1,3	1,3
8	16	3/8	16ER_8ACME_FC	1,5	1,5	16IR_8ACME_FC	1,5	1,5
6	16	3/8	16ER_6ACME_FC	1,7	1,8	16IR_6ACME_FC	1,7	1,8
6	22	1/2	22ER_6ACME_FC	1,8	2,1	22IR_6ACME_FC	1,8	2,1
5	22	1/2	22ER_5ACME_FC	2,0	2,3	22IR_5ACME_FC	2,0	2,3
4	27	5/8	27ER_4ACME_FC	2,3	2,7	27IR_4ACME_FC	2,3	2,7

## STACME

### STUB ACME

Pitch TPI	L mm	IC inch	EXTERNAL Part Number	X mm	Y mm	INTERNAL Part Number	X mm	Y mm
16	16	3/8	16ER_16STACME_FC	1,0	1,0	16IR_16STACME_FC	1,0	1,0
14	16	3/8	16ER_14STACME_FC	1,1	1,1	16IR_14STACME_FC	1,1	1,1
12	16	3/8	16ER_12STACME_FC	1,2	1,2	16IR_12STACME_FC	1,2	1,2
10	16	3/8	16ER_10STACME_FC	1,3	1,3	16IR_10STACME_FC	1,3	1,3
8	16	3/8	16ER_8STACME_FC	1,5	1,5	16IR_8STACME_FC	1,5	1,5
6	16	1/2	16ER_6STACME_FC	1,8	1,8	16IR_6STACME_FC	1,8	1,8
5	22	1/2	22ER_5STACME_FC	2,0	2,3	22IR_5STACME_FC	2,0	2,3
4	27	5/8	27ER_4STACME_FC	2,3	2,4	27IR_4STACME_FC	2,3	2,4
3	27	5/8	27ER_3STACME_FC	2,8	2,9	27IR_3STACME_FC	2,8	2,9

- The Part Numbers are for Right Hand Inserts. For Left Hand specify L instead of R. The Price is 10% higher for L.
- All inserts have ground profile and chipbreaker if nothing else is indicated.



# THREAD TURNING INSERTS

## API RD

### API ROUND OIL THREAD

Pitch TPI	L mm	IC inch	Taper IPF	EXTERNAL Part Number	INTERNAL Part Number	X mm	Y mm
10	16	3/8	0,75	16ER_10APIRD_FC	16IR_10APIRD_FC	1,5	1,4
8	16	3/8	0,75	16ER_8APIRD_FC	16IR_8APIRD_FC	1,3	1,6

## V-0.040

### V-0.040 OIL THREAD

Pitch TPI	L mm	IC inch	Taper IPF	EXTERNAL Part Number	INTERNAL Part Number	X mm	Y mm	Connection or Size
5	22	1/2	3	22ER_5API403_FC	22IR_5API403_FC	1,8	2,5	2 <sup>3</sup> / <sub>8</sub> - 4 <sup>1</sup> / <sub>2</sub> REG

## V-0.038R

### V-0.038R OIL THREAD

Pitch TPI	L mm	IC inch	Taper IPF	EXTERNAL Part Number	INTERNAL Part Number	X mm	Y mm	Connection or Size
4	27	5/8	2	27ER_4API382_FC	27IR_4API382_FC	2,1	2,8	NC23-NC50
4	27	5/8	3	27ER_4API383_FC	27IR_4API383_FC	2,1	2,8	NC56-NC77

## V-0.050

### V-0.050 OIL THREAD

Pitch TPI	L mm	IC inch	Taper IPF	EXTERNAL Part Number	INTERNAL Part Number	X mm	Y mm	Connection or Size
4	27	5/8	2	27ER_4API502_FC	27IR_4API502_FC	2,0	3,0	6 <sup>5</sup> / <sub>8</sub> REG
4	27	5/8	3	27ER_4API503_FC	27IR_4API503_FC	2,0	3,0	5 <sup>1</sup> / <sub>2</sub> , 7 <sup>5</sup> / <sub>8</sub> , 8 <sup>5</sup> / <sub>8</sub> REG

## EL

### EXTREME - LINE CASING OIL THREAD

Pitch TPI	L mm	IC inch	Taper IPF	EXTERNAL Part Number	INTERNAL Part Number	X mm	Y mm	Connection or Size
6	22	1/2	1,50	22ER_6EL1.5_FC	22IR_6EL1.5_FC	1,9	1,9	5 - 7 <sup>5</sup> / <sub>8</sub>
5	22	1/2	1,25	22ER_5EL1.25_FC	22IR_5EL1.25_FC	2,4	2,3	8 <sup>5</sup> / <sub>8</sub> - 10 <sup>3</sup> / <sub>4</sub>

## BUT

### BUTTRESS CASING OIL THREAD

Pitch TPI	L mm	IC inch	Taper IPF	EXTERNAL Part Number	INTERNAL Part Number	X mm	Y mm	Connection or Size
5	22	1/2	0,75	22ER_5BUT0.75_FC	22IR_5BUT0.75_FC	2,2	2,4	4 <sup>1</sup> / <sub>2</sub> - 13 <sup>3</sup> / <sub>8</sub>
5	22	1/2	1,00	22ER_5BUT1.0_FC	22IR_5BUT1.0_FC	2,3	2,4	16 - 20

■ The Part Numbers are for Right Hand Inserts. For Left Hand specify L instead of R. The Price is 10% higher for L.

■ All inserts have ground profile and chipbreaker if nothing else is indicated.

# THREAD TURNING INSERTS



## Triangular Multitooth

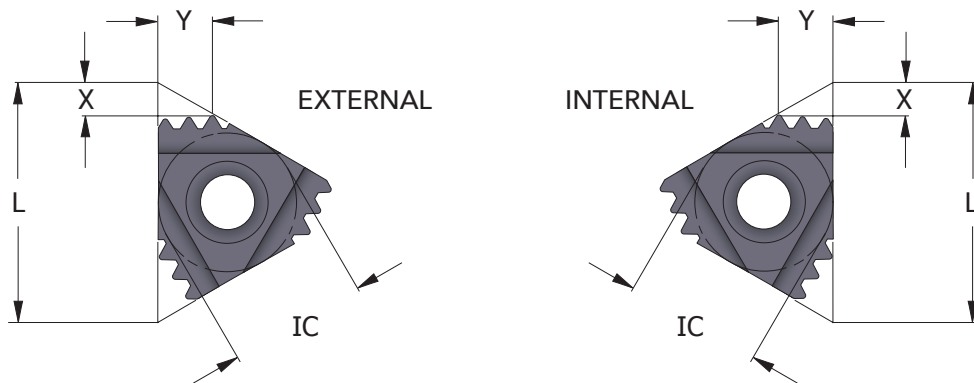

### M

### METRIC

Pitch mm	L mm	IC inch	EXTERNAL Part Number	X mm	Y mm	INTERNAL Part Number	X mm	Y mm
1,0	16	3/8	16ER_1.0ISO3M_FC	1,7	2,5	16IR_1.0ISO3M_FC	1,7	2,5
1,5	16	3/8	16ER_1.5ISO2M_FC	1,5	2,3	16IR_1.5ISO2M_FC	1,5	2,3
1,5	22	1/2	22ER_1.5ISO3M_FC	2,3	3,7	22IR_1.5ISO3M_FC	2,3	3,7
2,0	22	1/2	22ER_2.0ISO2M_FC	2,0	3,0	22IR_2.0ISO2M_FC	2,0	3,0
2,0	22	1/2	22ER_2.0ISO3M_FC	3,1	5,0	22IR_2.0ISO3M_FC	3,1	5,0
3,0	27	5/8	27ER_3.0ISO2M_FC	2,9	4,5	27IR_3.0ISO2M_FC	2,9	4,5

### UN

### UNIFIED

Pitch TPI	L mm	IC inch	EXTERNAL Part Number	X mm	Y mm	INTERNAL Part Number	X mm	Y mm
16	16	3/8	16ER_16UN2M_FC	1,5	2,3	16IR_16UN2M_FC	1,5	2,3
16	16	3/8	22ER_16UN3M_FC	2,5	4,0	22IR_16UN3M_FC	2,5	4,0
12	22	1/2	22ER_12UN2M_FC	2,2	3,4	22IR_12UN2M_FC	2,2	3,4
12	22	1/2	22ER_12UN3M_FC	3,3	5,3	22IR_12UN3M_FC	3,3	5,3
8	27	5/8	27ER_8UN2M_FC	3,1	4,9	27IR_8UN2M_FC	3,1	4,9

### G/Rp

### WHITWORTH PIPE THREAD

Pitch TPI	L mm	IC inch	EXTERNAL Part Number	X mm	Y mm	INTERNAL Part Number	X mm	Y mm
14	16	3/8	16ER_14W2M_FC	1,7	2,7	16IR_14W2M_FC	1,7	2,7
14	22	1/2	22ER_14W3M_FC	2,8	4,5	22IR_14W3M_FC	2,8	4,5
11	22	1/2	22ER_11W2M_FC	2,3	3,4	22IR_11W2M_FC	2,3	3,4

### NPT

### NPT PIPE THREAD

Pitch TPI	L mm	IC inch	EXTERNAL Part Number	X mm	Y mm	INTERNAL Part Number	X mm	Y mm
11,5	22	1/2	22ER_11.5NPT2M_FC	2,3	3,5	22IR_11.5NPT2M_FC	2,3	3,5
11,5	27	5/8	27ER_11.5NPT3M_FC	3,3	5,5	27IR_11.5NPT3M_FC	3,3	5,5
8	27	5/8	27ER_8NPT2M_FC	3,1	5,0	27IR_8NPT2M_FC	3,1	5,0

### API RD

### API ROUND OIL THREAD

Pitch TPI	L mm	IC inch	Taper IPF	EXTERNAL Part Number	INTERNAL Part Number	X mm	Y mm
10	22	1/2	0,75	22ER_10APIRD2M_FC	22IR_10APIRD2M_FC	2,4	3,7
10	27	5/8	0,75	27ER_10APIRD3M_FC	27IR_10APIRD3M_FC	3,8	6,2
8	27	5/8	0,75	27ER_8APIRD2M_FC	27IR_8APIRD2M_FC	3,0	4,5

# THREAD TURNING INSERTS

## Kits with Different Inserts

### External Threading Inserts Kits



Part Number

10X16ER\_FC



Part Number

10X22ER\_FC

*External Toolholder*



# THREAD TURNING INSERTS

## Kits with Different Inserts



### Internal Threading Inserts Kits

0.5 ISO	0.75 ISO	1.0 ISO	1.25 ISO	A60
0.5 ISO	0.75 ISO	1.0 ISO	1.25 ISO	A60

**Part Number**

10X06IR\_Ø5\_BC

■ Recommended holder: SIR\_0005\_H06

1.0 ISO	1.5 ISO	1.75 ISO	28W	A60
1.0 ISO	1.5 ISO	1.75 ISO	28W	A60

**Part Number**

10X08IR\_Ø7\_BC

■ Recommended holder: SIR\_0007\_K08

1.0 ISO	1.5 ISO	2.0 ISO	19W	A60
1.0 ISO	1.5 ISO	2.0 ISO	19W	A60

**Part Number**

10X11IR\_Ø10\_FC

■ Recommended holder: SIR\_0010\_K11

1.5 ISO	2.0 ISO	2.5 ISO	3.0 ISO	14W
1.5 ISO	2.0 ISO	2.5 ISO	3.0 ISO	14W

**Part Number**

10X16IR\_Ø13\_FC

■ Recommended holder: SIR\_0013\_M16

1.5 ISO	2.0 ISO	3.0 ISO	11W	AG60
1.5 ISO	2.0 ISO	3.0 ISO	11W	AG60

**Part Number**

10X16IR\_Ø20\_FC

■ Recommended holder: SIR\_0020\_P16

3.5 ISO	4.0 ISO	4.5 ISO	5.0 ISO	N60
3.5 ISO	4.0 ISO	4.5 ISO	5.0 ISO	N60

**Part Number**

10X22IR\_Ø25\_FC

■ Recommended holder: SIR\_0025\_R22



Internal Toolholder

# THREAD TURNING TOOLHOLDERS

## External



Insert mm	Part Number	B/H mm	L mm	F mm
16	SER_1212_F16	12	80	16
16	SER_1616_H16	16	100	16
16	SER_2020_K16	20	125	20
16	SER_2525_M16	25	150	25
16	SER_3232_P16	32	170	32
22	SER_2525_M22	25	150	25
22	SER_3232_P22	32	170	32
22	SER_4040_R22	40	200	40
27	SER_2525_M27	25	150	32
27	SER_3232_P27	32	170	32
27	SER_4040_R27	40	200	40

## Spare Parts

Insert mm	Screw to insert	Torx key	Screw to anvil	Anvil
16	S16	K16	A16	AE16...
22	S22	K22	A22	AE22...
27	S27	K27	A27	AE27...

■ The Part Numbers are for Right Hand Toolholders. For Left Hand specify L instead of R. The Price is 10% higher for L.

■ Toolholders are supplied with anvil for helix angle 1,5°. [For other helix angles, see page 42.](#) Ex. anvil part number: AE16+0.5

# THREAD TURNING TOOLHOLDERS

## Internal

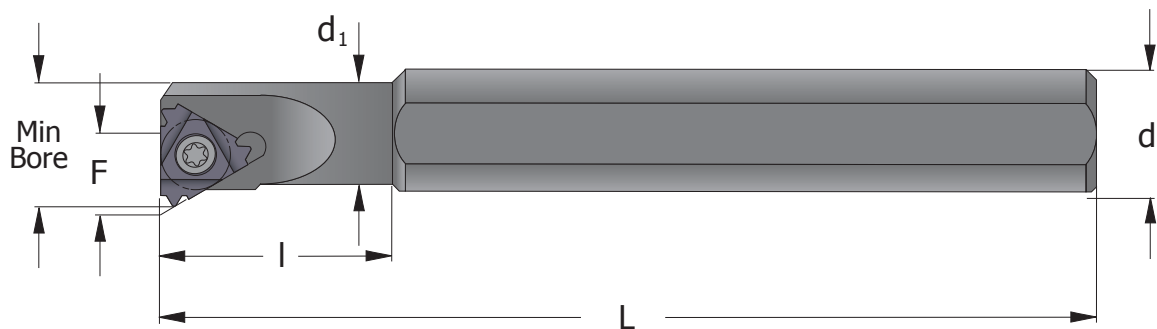

Insert mm	Min Bore mm	Part Number	d mm	d <sub>1</sub> mm	l mm	L mm	F mm
6	6,3	SIR_0005_H06*	12	5,1	12	100	4,3
8	8	SIR_0007_K08*	16	6,6	18	125	5,3
11	12	SIR_0010_H11*	10	10		100	7,4
11	12	SIR_0010_K11*	16	10	25	125	7,4
11	15	SIR_0013_L11*	16	13	32	140	8,9
16	16	SIR_0013_M16*	16	13	32	150	10,2
16	19	SIR_0016_P16*	20	16	40	170	11,7
16	23	SIR_0020_P16	20	20		170	13,7
16	28	SIR_0025_R16	25	25		200	16,2
16	35	SIR_0032_S16	32	32		250	19,7
16	43	SIR_0040_T16	40	40		300	23,7
22	24	SIR_0020_P22*	20	20		170	15,6
22	29	SIR_0025_R22	25	25		200	18,1
22	36	SIR_0032_S22	32	32		250	21,6
22	44	SIR_0040_T22	40	40		300	25,6
27	37	SIR_0032_S27	32	32		250	22,6
27	45	SIR_0040_T27	40	40		300	26,6
27	55	SIR_0050_U27	50	50		350	31,6
27	65	SIR_0060_V27	60	60		400	36,6

## with Carbide Shank and Internal Coolant

Insert mm	Min Bore mm	Part Number	d mm	d <sub>1</sub> mm	l mm	L mm	F mm
6	6,3	SIR_0005_H06CB*	6	5,1	26	100	4,3
8	8	SIR_0007_K08CB*	8	6,6	31	125	5,3
11	12	SIR_0010_M11CB*	10	10		150	7,4
11	14	SIR_0012_P11CB*	12	12		170	8,4
16	19	SIR_0016_R16CB*	16	16		200	11,7
16	23	SIR_0020_S16CB	20	20		250	13,7
16	28	SIR_0025_S16CB	25	25		250	16,2
22	24	SIR_0020_S22CB*	20	20		250	15,6

## Spare Parts

Insert mm	Screw to insert	Torx key	Screw to anvil	Anvil
06	S6	K6		
08	S8	K8		
11	S11	K11		
16	S16	K16	A16	AI16...
22	S22	K22	A22	AI22...
27	S27	K27	A27	AI27...

\* Toolholder without anvil (helix angle 1,5°)

# THREAD TURNING INSERTS

## U-type

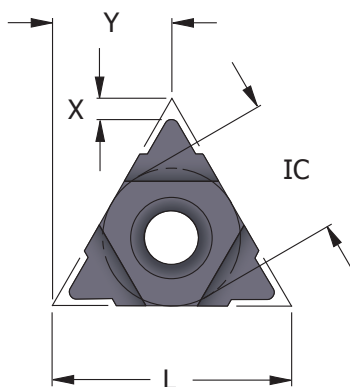

## M

### METRIC

Pitch mm	L mm	IC inch	EXTERNAL Part Number	X mm	Y mm	INTERNAL Part Number	X mm	Y mm
2,0	8	3/16				08UI_2.0ISO_BC	0,9	4,0
5,5	22	1/2	22UE_5.5ISO_FC	2,3	11,0	22UI_5.5ISO_FC	2,4	11,0
6,0	22	1/2	22UE_6.0ISO_FC	2,6	11,0	22UI_6.0ISO_FC	2,1	11,0
8,0	27	5/8	27UE_8.0ISO_FC	2,4	13,7	27UI_8.0ISO_FC	2,4	13,7
12,0	33	3/4	33UE_12.0ISO_FC	2,5	16,5	33UI_12.0ISO_FC	3,5	16,9

## UN

### UNIFIED

Pitch TPI	L mm	IC inch	EXTERNAL Part Number	X mm	Y mm	INTERNAL Part Number	X mm	Y mm
13	8	3/16				08UI_13UN_BC	1,0	4,0
12	8	3/16				08UI_12UN_BC	0,9	4,0
11	8	3/16				08UI_11UN_BC	0,9	4,0
4,5	22	1/2	22UE_4.5UN_FC	2,0	11,0	22UI_4.5UN_FC	2,4	11,0
4	22	1/2	22UE_4UN_FC	2,0	11,0	22UI_4UN_FC	2,4	11,0
3	27	5/8	27UE_3UN_FC	2,5	13,7	27UI_3UN_FC	2,7	13,7
2	33	3/4	33UE_2UN_FC	2,8	16,5	33UI_2UN_FC	3,6	16,9

## TR

### TRAPEZ DIN 103

Pitch mm	L mm	IC inch	EXTERNAL Part Number	X mm	Y mm	INTERNAL Part Number	X mm	Y mm
2,0	8					08UI_2.0TR_BC	0,9	4,0
6,0	22	1/2	22UE_6.0TR_FC	2,0	11,0	22UI_6.0TR_FC	2,0	11,0
7,0	22	1/2	22UE_7.0TR_FC	2,3	11,0	22UI_7.0TR_FC	2,3	11,0
8,0	22	1/2	22UE_8.0TR_FC	2,5	11,0	22UI_8.0TR_FC	2,5	11,0
8,0	27	5/8	27UE_8.0TR_FC	2,5	13,7	27UI_8.0TR_FC	2,5	13,7
9,0	27	5/8	27UE_9.0TR_FC	3,0	13,7	27UI_9.0TR_FC	3,0	13,7
10,0	27	5/8	27UE_10.0TR_FC*	3,2	13,7	27UI_10.0TR_FC*	3,2	13,7
12,0	33	3/4	33UE_12.0TR_FC	3,9	16,9	33UI_12.0TR_FC	3,9	16,9

■ All inserts have ground profile and chipbreaker.

\* Only one cutting edge



# THREAD TURNING INSERTS



## ACME

## ACME

Pitch TPI	L mm	IC inch	EXTERNAL Part Number	X mm	Y mm	INTERNAL Part Number	X mm	Y mm
14	8	3/16				08UI_14ACME_BC	0,8	4,0
12	8	3/16				08UI_12ACME_BC	0,8	4,0
10	8	3/16				08UI_10ACME_BC	0,8	4,0
4	22	1/2	22UE_4ACME_FC	2,3	11,0	22UI_4ACME_FC	2,3	11,0
3	27	5/8	27UE_3ACME_FC	2,8	13,7	27UI_3ACME_FC	2,8	13,7
2	33	3/4	33UE_2ACME_FC	4,3	16,9	33UI_2ACME_FC	4,3	16,9

## STACME

## STUB ACME

Pitch TPI	L mm	IC inch	EXTERNAL Part Number	X mm	Y mm	INTERNAL Part Number	X mm	Y mm
14	8	3/16				08UI_14STACME_BC	0,8	4,0
12	8	3/16				08UI_12STACME_BC	0,9	4,0
10	8	3/16				08UI_10STACME_BC	1,0	4,0
4	22	1/2	22UE_4STACME_FC	2,5	11,0	22UI_4STACME_FC	2,5	11,0
3	22	1/2	22UE_3STACME_FC	3,3	11,0	22UI_3STACME_FC	3,3	11,0
2	33	3/4	33UE_2STACME_FC	5,0	16,9	33UI_2STACME_FC	5,0	16,9

## BS/G/Rp

## WHITWORTH

Pitch TPI	L mm	IC inch	EXTERNAL Part Number	X mm	Y mm	INTERNAL Part Number	X mm	Y mm
12	8	3/16				08UI_12W_BC	0,9	4,0
4,5	22	1/2	22U_4.5W_FC	2,3	11,0	22U_4.5W_FC	2,3	11,0
4	22	1/2	22U_4W_FC	2,8	11,0	22U_4W_FC	2,8	11,0
3,5	27	5/8	27U_3.5W_FC	2,1	13,7	27U_3.5W_FC	2,1	13,7
3,25	27	5/8	27U_3.25W_FC	2,0	13,7	27U_3.25W_FC	2,0	13,7
3	27	5/8	27U_3W_FC	2,3	13,7	27U_3W_FC	2,3	13,7
2,75	27	5/8	27U_2.75W_FC	2,4	13,7	27U_2.75W_FC	2,4	13,7

### U-type vs conventional inserts

The advantage of U-type inserts is that it is possible to make a larger thread profile than on a conventional insert. For example, on size 22 you can make 8.0TR with U-type, but maximum with conventional insert is 6.0TR.

The disadvantage is that you cannot thread against a shoulder because the thread profile is in the center of the insert.



# THREAD TURNING TOOLHOLDERS

## U-type External



Insert mm	Part Number	B/H mm	L mm	F mm
22	SER_2525_M22U	25	150	28
22	SER_3232_P22U	32	170	32
22	SER_4040_R22U	40	200	40
27	SER_2525_M27U	25	150	32
27	SER_3232_P27U	32	170	32
27	SER_4040_R27U	40	200	40
33	SER_2525_M33U*	25	150	32
33	SER_3232_P33U*	32	170	32

## Spare Parts

Insert mm	Screw to insert	Torx key	Screw to anvil	Anvil
22	S22	K22	A22	AE22U...
27	S27	K27	A27	AE27U...
33	S33	K33		

■ The Part Numbers are for Right Hand Toolholders. For Left Hand specify L instead of R. The Price is 10% higher for L.

■ Toolholders are supplied with anvil for helix angle 1,5°. [For other helix angles, see page 42.](#) Ex. anvil part number: AE22U+0.5

\* Toolholder without anvil (helix angle 1,5°)

# THREAD TURNING TOOLHOLDERS

## U-type Internal

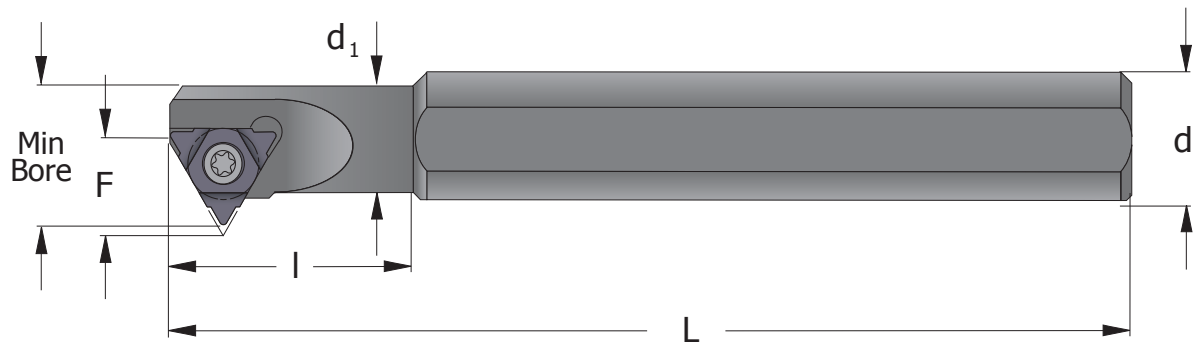

Insert mm	Min Bore mm	Part Number	d mm	d <sub>1</sub> mm	l mm	L mm	F mm
8	9,5	SIR_0008_K08U*	16	7,3	21	125	6,6
22	39	SIR_0032_S22U	32	32	-	250	24,4
22	46	SIR_0040_T22U	40	40	-	300	28,1
27	40	SIR_0032_S27U	32	32	-	250	25,8
27	47	SIR_0040_T27U	40	40	-	300	29,4
27	57	SIR_0050_U27U	50	50	-	350	34,3
27	68	SIR_0060_V27U	60	60	-	400	39,7
33	59	SIR_0050_U33U*	50	50	-	350	37,5

## with Carbide Shank and Internal Coolant

Insert mm	Min Bore mm	Part Number	d mm	d <sub>1</sub> mm	l mm	L mm	F mm
8	9,5	SIR_0008_K08UCB*	8	7,3	35	125	6,6

## Spare Parts

Insert mm	Screw to insert	Torx key	Screw to anvil	Anvil
08	S8	K8		
22	S22	K22	A22	AI22U...
27	S27	K27	A27	AI27U...
33	S33	K33		

■ The Part Numbers are for Right Hand Toolholders. For Left Hand specify L instead of R. The Price is 10% higher for L.

■ Toolholders are supplied with anvil for helix angle 1,5°. [For other helix angles, see page 42.](#) Ex. anvil part number: AI22U+0.5

\* Toolholder without anvil (helix angle 1,5°)

# THREAD TURNING INSERTS

## Micro

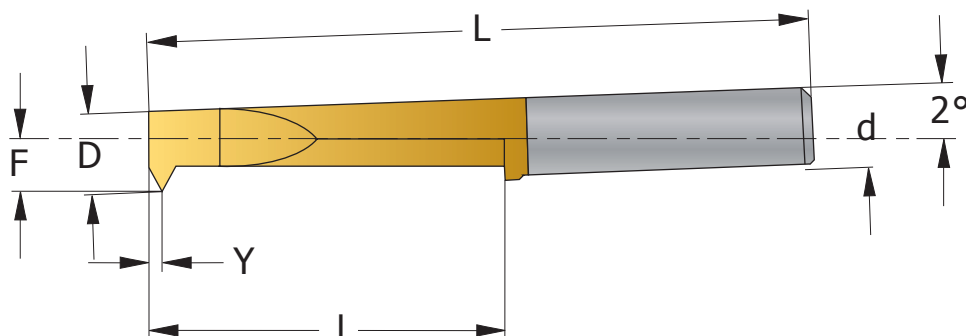

## 60°

### PARTIAL PROFILE 60°

Pitch mm	TPI	D mm	INTERNAL Part Number	d mm	l mm	L mm	F mm	Y mm
0,2-0,4	80 - 64	0,8	WR308_P60_BC	3	4	24	0,5	0,2
0,2-0,6	80 - 44	1,6	WR316_P60_BC	3	7	24	0,75	0,3
0,2-0,8	80 - 32	2,2	WR322_P60_BC	3	10	24	1,25	0,4
0,2-1,0	80 - 28	3,0	WR330_P60_BC	3	12	24	1,5	0,5
0,25-1,25	80 - 20	4,0	WR440_P60_BC	4	16,5	32	2	0,6
0,25-1,5	80 - 18	5,0	WR550_P60_BC	5	21	40	2,5	0,7
0,25-1,75	80 - 14	6,0	WR660_P60_BC	6	27	48	3	0,8
0,35-2,5	72 - 10	8,0	WR880_P60_BC	8	45	72	4	1,2

## 55°

### PARTIAL PROFILE 55°

Pitch mm	TPI	D mm	INTERNAL Part Number	d mm	l mm	L mm	F mm	Y mm
0,25-1,25	80 - 20	4,0	WR440_P55_BC	4	16,5	32	2	0,6
0,25-1,75	80 - 18	6,0	WR660_P55_BC	6	27	48	3	0,8

■ Also available for Grooving and Turning

## Minimum Bore Diameter

To obtain highest possible stability the threading inserts are ground in an angle of 2°. Therefore the minimum bore diameter is dependent on the thread length according to the table below.

D mm	Thread Length (mm)															
	2	4	6	8	10	12	14	16	18	21	24	27	30	35	40	45
0,8	0,87	0,94														
1,6	1,67	1,74	1,81													
2,2	2,27	2,34	2,41	2,48	2,55											
3,0	3,07	3,14	3,21	3,28	3,35	3,42										
4,0	4,07	4,14	4,21	4,28	4,35	4,42	4,49	4,56								
5,0	5,07	5,14	5,21	5,28	5,35	5,42	5,49	5,56	5,63	5,74						
6,0	6,07	6,14	6,21	6,28	6,35	6,42	6,49	6,56	6,63	6,74	6,84	6,95				
8,0	8,07	8,14	8,21	8,28	8,35	8,42	8,49	8,56	8,63	8,74	8,84	8,95	9,05	9,23	9,40	9,58

■ Minimum Bore Diameter = D + (thread length x 0,035)

# THREAD TURNING TOOLHOLDERS

## Micro

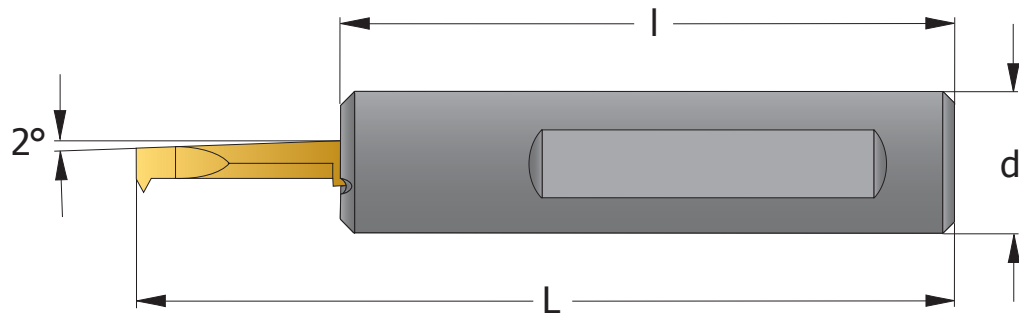

Insert mm	Part Number	d mm	l mm	L mm
3,0	WRC3N_0012E-2	12	70	82
3,0	WRC3N_0016F-2	16	80	92
3,0	WRC3N_0020H-2	20	100	112
3,0	WRC3N_0022J-2	22	110	122
3,0	WRC3N_0025J-2	25	110	122
4,0	WRC4N_0012E-2	12	75	91,5
4,0	WRC4N_0016F-2	16	85	101,5
4,0	WRC4N_0020H-2	20	105	121,5
4,0	WRC4N_0022J-2	22	115	131,5
4,0	WRC4N_0025J-2	25	115	131,5
5,0	WRC5N_0016G-2	16	90	111
5,0	WRC5N_0020J-2	20	110	131
5,0	WRC5N_0022J-2	22	120	141
5,0	WRC5N_0025J-2	25	120	141
6,0	WRC6N_0016G-2	16	95	121
6,0	WRC6N_0020J-2	20	115	141
6,0	WRC6N_0022K-2	22	125	151
6,0	WRC6N_0025K-2	25	125	151
8,0	WRC8N_0020J-2	20	120	165
8,0	WRC8N_0022K-2	22	130	175
8,0	WRC8N_0025K-2	25	130	175

■ Also available in 3/4" och 1" (for Citizen).

*Micro Thread Turning  
from pitch 0,2 mm.*







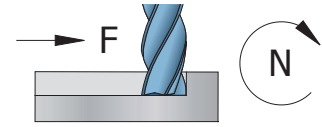



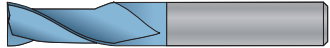









Technical Information

74



### SOLID CARBIDE END MILLS

LC	M	Two Flute	76	
LC	M	Three Flute	77	
LC	M	Four Flute	78	
LC	R	Two Flute, with Ball Nose	79	
LC	MZ	Variable Flute 35° and 38°	80	
LC	MV	Slot Side End Mill	81	
LC	FW	Wave formed Roughing End Mill, Three Flute	82	
LC	FW	Wave formed Roughing End Mill, Four Flute	83	
MG	MA	Two Flute, for aluminium	84	
MG	MA	Three Flute, for aluminium	85	
MG	FWA	Wave formed Roughing End Mill, aluminium	86	
FC	M	Two Flute	87	
FC	M	Three Flute	88	
FC	M	Four Flute	89	
FC	M..R	Two Flute, with Corner Radius	90	
FC	M..R	Four Flute, with Corner Radius	91	
FC	R	Two Flute, with Ball Nose	92	
FC	R..L	Two Flute, with Ball Nose, Long Shank	92	
FC	R	Four Flute, with Ball Nose	93	

FC	U & V	High Helix	94
FC	TH	Roughing End Mill	95

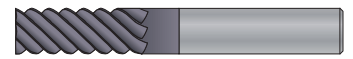

### MOLD AND DIE END MILLS

FC	MP	Micro, Two Flute	96
FC	RP	Micro, Two Flute, with Ball Nose	98
FC	MH	Two Flute, with Corner Radius	100
FC	MH	Four Flute, with Corner Radius	101
FC	RH	Two Flute, with Ball Nose	102
FC	RH	Four Flute, with Ball Nose	103

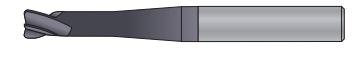
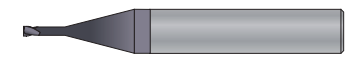

### DIAMOND COATED END MILLS

DC	MG	Micro, Two Flute	104
DC	RG	Micro, Two Flute, with Ball Nose	105
DC	MG	Three Flute, with Corner Radius	106
DC	MG..L	Two Flute, with Corner Radius, Long Shank	106
DC	MG	Two/Four Flute, with Corner Radius	107
DC	RG	Three Flute, with Ball Nose	108
DC	RG..L	Two Flute, with Ball Nose, Long Shank	108
DC	RG	Two/Four Flute, with Ball Nose	109

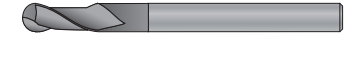
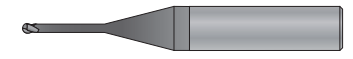



## Cutting Speed ( $V_c$ ) and Material Factor ( $F_m$ )

MATERIAL		Hardness HB	Tensile Strength N/mm <sup>2</sup>	Cutting Speed ( $V_c$ ) m/min	Material Factor ( $F_m$ )
Steel	Low carbon, C < 0,25%	< 120	< 400	150 - 200	1,2
	Medium carbon, C < 0,55%	< 200	< 700	120 - 170	1,1
	High carbon, C < 0,85%	< 250	< 850	110 - 150	1,0
	Low alloy	< 250	< 850	100 - 140	1,0
	High alloy	< 350	< 1200	70 - 110	0,9
	Hardened, HRC < 45			60 - 100	0,8
	Hardened, HRC < 55			30 - 60	0,7
	Hardened, HRC < 65			20 - 40	0,6
Cast iron	Lamellar graphite	< 150	< 500	130 - 180	1,2
	Lamellar graphite	< 300	< 1000	100 - 150	1,1
	Nodular graphite, malleable	< 200	< 700	100 - 150	1,0
	Nodular graphite, malleable	< 300	< 1000	80 - 120	0,9
Stainless steel	Free machining	< 250	< 850	130 - 180	1,0
	Austenitic	< 250	< 850	90 - 140	0,9
	Ferritic and austenitic	< 300	< 1000	80 - 120	0,8
Titanium	Unalloyed	< 200	< 700	60 - 80	0,8
	Alloyed	< 270	< 900	50 - 70	0,7
	Alloyed	< 350	< 1250	30 - 50	0,6
Nickel	Unalloyed	< 150	< 500	80 - 120	0,8
	Alloyed	< 270	< 900	60 - 80	0,7
	Alloyed	< 350	< 1250	50 - 70	0,6
Copper	Unalloyed	< 100	< 350	150 - 250	1,0
	Brass, bronze	< 200	< 700	130 - 180	1,0
	High strength bronze	< 470	< 1500	60 - 80	0,8
Aluminium	Unalloyed	< 100	< 350	500 - 900	1,4
	Alloyed, Si < 0.5%	< 150	< 500	400 - 800	1,3
	Alloyed, Si < 10%	< 120	< 400	300 - 500	1,2
	Alloyed, Si > 10%	< 120	< 400	200 - 400	1,1
Inconel	718	< 370		50 - 70	0,6
Graphite				300 - 500	1,0

## Code Key

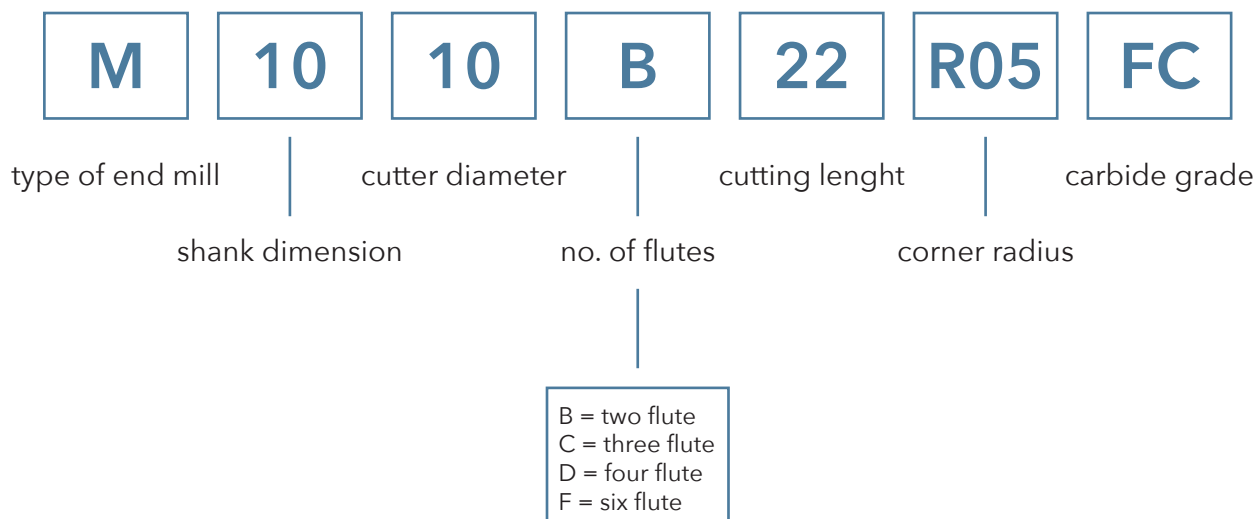

### Engagement Factor ( $F_e$ )

	Side Milling				Slot Milling $a_e = 1,0 \times D$
	$a_e = 0,1 \times D$	$a_e = 0,25 \times D$	$a_e = 0,5 \times D$	$a_e = 0,75 \times D$	
$a_p = 0,25 \times D$	3,5	1,8	1,4	1,2	1,0
$a_p = 0,5 \times D$	3,0	1,5	1,2	0,9	0,7
$a_p = 0,75 \times D$	2,5	1,3	1,0	0,7	0,6
$a_p = 1,0 \times D$	2,0	1,1	0,8	0,6	0,5
$a_p = 1,25 \times D$	1,7	0,9	0,6		
$a_p = 1,5 \times D$	1,4	0,7			
$a_p = 2,0 \times D$	1,2	0,5			
$a_p = 2,5 \times D$	1,0				
$a_p = 3,0 \times D$	0,8				

#### Side Milling

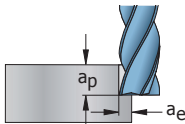

$$F_z = F_m \times F_e \times F_d$$

#### Slot Milling

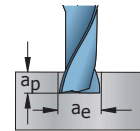

### Diameter Factor ( $F_d$ )

- D = cutter diameter (mm)
- $F_z$  = feed / flute (mm/flute)
- n = spindle speed (rpm)
- $V_c$  = cutting speed (m/min)
- $V_f$  = table feed (mm/min)
- z = no. of flutes

D	Diameter Factor ( $F_d$ )
0,5	0,004
1,0	0,006
2,0	0,009
3,0	0,012
4,0	0,016
5,0	0,022
6,0	0,032
8,0	0,045
10,0	0,056
12,0	0,074
14,0	0,086
16,0	0,098
18,0	0,110
20,0	0,122
25,0	0,135
32,0	0,145
40,0	0,155

$$n = \frac{V_c \times 1000}{\pi \times D}$$

$$V_f = F_z \times z \times n$$

#### Example

Side Milling with M1010D25 LC  
 Standard Length Four Flute End Mill  
 Carbon Steel, up to 700 N/mm<sup>2</sup>  
 D = 10 mm  
 $a_p = 1,0 \times D = 10$  mm  
 $a_e = 0,25 \times D = 2,5$  mm  
 $F_z = 1,1 \times 1,1 \times 0,056 = 0,068$  mm/flute  
 $n = (130 \times 1000) / (\pi \times 10) = 4138$  rpm  
 $V_f = 0,068 \times 4 \times 4138 = 1126$  mm/min

### Cutting Data Tables

Go to our website to download a PDF with cutting parameters for side milling, slot milling, and high-speed milling.



### Carbide Grades

**LC** Super Micrograin Carbide with AlCrN coating. All-round grade, combination of toughness and heat resistance. Use cutting data according to the tables.

**MG** Uncoated Super Micrograin Carbide. For Aluminium. Use cutting data according to the tables.

**FC** Micrograin Carbide with TiAlN coating. All-round grade with high heat resistance. Use cutting data according to the tables.

**DC** Micrograin Carbide with Diamond coating. For Graphite. Use cutting data according to the tables.

## Two Flute

**LC**  
 AlCrN coated  
 Super Micrograin Carbide  
**Tolerance**  
 D 1,0 - 5,0 +0 / -0,020  
 D 6,0 - 7,0 +0 / -0,025  
 D 8,0 - 9,0 +0 / -0,030  
 D 10,0 - 12,0 +0 / -0,035  
**Shank**  
 Cylindrical h6, DIN6535 HA  
**Flute**  
 35° right hand spiral, center cutting  
**Field of application**  
 All types of steel up to HRC55

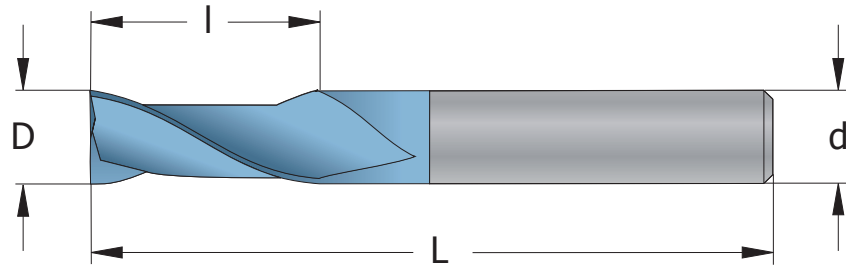

D mm	d mm	Part Number	l mm	L mm	No. of Flutes
1,0	4	M0401B3_LC	3	50	2
1,5	4	M04015B4_LC	4	50	2
2,0	4	M0402B6_LC	6	50	2
2,5	4	M04025B8_LC	8	50	2
3,0	4	M0403B8_LC	8	50	2
3,0	6	M0603B8_LC	8	57	2
4,0	4	M0404B11_LC	11	50	2
4,0	6	M0604B11_LC	11	57	2
5,0	6	M0605B13_LC	13	57	2
6,0	6	M0606B16_LC	16	57	2
8,0	8	M0808B20_LC	20	63	2
10,0	10	M1010B25_LC	25	72	2
12,0	12	M1212B30_LC	30	83	2

### Solid Carbide End Mills with LC grade

Choose SmiCut's Solid Carbide End Mills for a reliable, high-quality tool that delivers top-tier performance. Our LC grade (AlCrN-coated) end mills are the ideal choice for high-performance milling in all types of steel. Experience the numerous advantages of our LC grade end mills:

- Super Micrograin Carbide
- Extremely tight tolerances
- High heat resistance coating
- Long tool life
- Best price-to-value ratio



## Three Flute

**LC**

AlCrN coated

Super Micrograin Carbide

**Tolerance**

D 1,0 - 5,0 +0 / -0,020

D 6,0 - 7,0 +0 / -0,025

D 8,0 - 9,0 +0 / -0,030

D 10,0 - 12,0 +0 / -0,035

**Shank**

Cylindrical h6, DIN6535 HA

**Flute**

35° right hand spiral, center cutting

**Field of application**

All types of steel up to HRC55

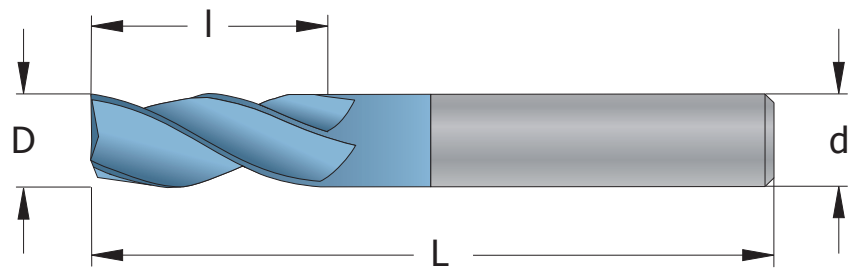

D mm	d mm	Part Number	l mm	L mm	No. of Flutes
1,0	4	M0401C3_LC	3	50	3
1,5	4	M04015C4_LC	4	50	3
2,0	4	M0402C6_LC	6	50	3
2,5	4	M04025C8_LC	8	50	3
3,0	4	M0403C8_LC	8	50	3
3,0	6	M0603C8_LC	8	57	3
4,0	4	M0404C11_LC	11	50	3
4,0	6	M0604C11_LC	11	57	3
5,0	6	M0605C13_LC	13	57	3
6,0	6	M0606C10_LC	10	50	3
6,0	6	M0606C16_LC	16	57	3
8,0	8	M0808C12_LC	12	57	3
8,0	8	M0808C20_LC	20	63	3
10,0	10	M1010C15_LC	15	63	3
10,0	10	M1010C25_LC	25	72	3
12,0	12	M1212C18_LC	18	72	3
12,0	12	M1212C30_LC	30	83	3

Available in two  
different lengths in  
Ø6, 8, 10 and 12 mm.



## Four Flute

**LC**  
AlCrN coated  
Super Micrograin Carbide

**Tolerance**

- D 1,0 - 5,0 +0 / -0,020
- D 6,0 - 7,0 +0 / -0,025
- D 8,0 - 9,0 +0 / -0,030
- D 10,0 - 12,0 +0 / -0,035
- D 16,0 - 20,0 +0 / -0,040

**Shank**

Cylindrical h6, DIN6535 HA

**Flute**

35° right hand spiral, center cutting

**Field of application**

All types of steel up to HRC55

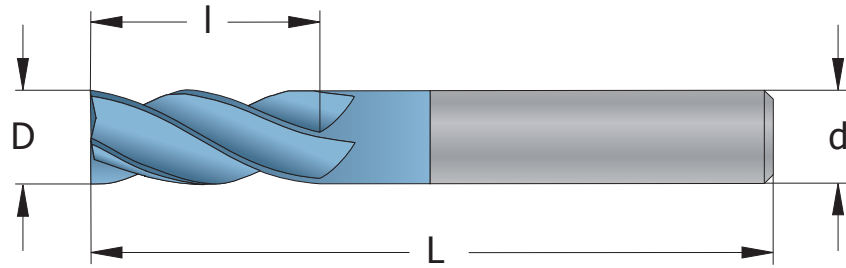

D mm	d mm	Part Number	l mm	L mm	No. of Flutes
2,0	4	M0402D6_LC	6	50	4
3,0	4	M0403D8_LC	8	50	4
3,0	6	M0603D8_LC	8	57	4
4,0	4	M0404D11_LC	11	50	4
4,0	6	M0604D11_LC	11	57	4
5,0	6	M0605D13_LC	13	57	4
6,0	6	M0606D10_LC	10	50	4
6,0	6	M0606D16_LC	16	57	4
6,0	6	M0606D26_LC	26	72	4
7,0	8	M0807D18_LC	18	63	4
8,0	8	M0808D12_LC	12	57	4
8,0	8	M0808D20_LC	20	63	4
8,0	8	M0808D32_LC	32	83	4
10,0	10	M1010D15_LC	15	63	4
10,0	10	M1010D25_LC	25	72	4
10,0	10	M1010D40_LC	40	92	4
12,0	12	M1212D18_LC	18	72	4
12,0	12	M1212D30_LC	30	83	4
12,0	12	M1212D48_LC	48	100	4
16,0	16	M1616D34_LC	34	92	4
20,0	20	M2020D40_LC	40	100	4

Available in three  
different lengths in  
Ø6, 8, 10 and 12 mm.



## Two Flute, with Ball Nose

**LC**

AlCrN coated

Super Micrograin Carbide

**Tolerance**

D 1,0 - 5,0 +0 / -0,020

D 6,0 - 7,0 +0 / -0,025

D 8,0 - 9,0 +0 / -0,030

D 10,0 - 12,0 +0 / -0,035

**Shank**

Cylindrical h6, DIN6535 HA

**Flute**

30° right hand spiral, center cutting

**Field of application**

All types of steel up to HRC55

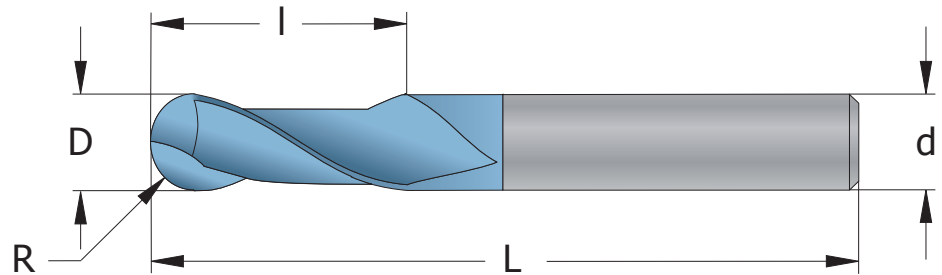

D mm	d mm	R mm	Part Number	l mm	L mm	No. of Flutes
1,0	4	0,5	R0401B2_LC	2	50	2
1,5	4	0,75	R04015B3_LC	3	50	2
2,0	4	1,0	R0402B4_LC	4	50	2
2,5	4	1,25	R04025B5_LC	5	50	2
3,0	4	1,5	R0403B6_LC	6	50	2
3,0	6	1,5	R0603B6_LC	6	57	2
4,0	4	2,0	R0404B8_LC	8	50	2
4,0	6	2,0	R0604B8_LC	8	57	2
5,0	6	2,5	R0605B10_LC	10	57	2
6,0	6	3,0	R0606B12_LC	12	57	2
8,0	8	4,0	R0808B16_LC	16	63	2
10,0	10	5,0	R1010B20_LC	20	72	2
12,0	12	6,0	R1212B24_LC	24	83	2



## Variable Flute 35° and 38°

**LC**  
 AlCrN coated  
 Super Micrograin Carbide  
**Tolerance**  
 D 6,0 - 7,0 +0 / -0,025  
 D 8,0 - 9,0 +0 / -0,030  
 D 10,0 - 12,0 +0 / -0,035  
**Shank**  
 Cylindrical h6, DIN6535 HA  
**Flute**  
 35° and 38° right hand spiral, center cutting  
**Field of application**  
 All types of steel up to HRC55

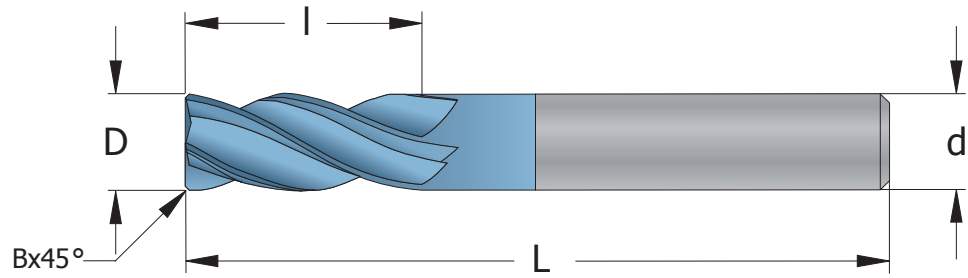

D mm	d mm	B mm	Part Number	l mm	L mm	No. of Flutes
6,0	6	0,2	MZ0606D16_LC	16	57	4
8,0	8	0,25	MZ0808D20_LC	20	63	4
10,0	10	0,3	MZ1010D25_LC	25	72	4
12,0	12	0,3	MZ1212D30_LC	30	83	4

### Variable Flute for Optimal Performance

Our End Mills with Variable Flutes are designed to deliver high-speed machining and excellent surface finish. The varying helix angles reduce vibration and distribute the cutting forces evenly, ensuring smooth operation and longer tool life. Ideal for diverse materials, these end mills provide a balance of speed, precision, and durability for optimal machining performance.



*Less vibrations with two different angles*

## Slot Side End Mill

**LC**

AlCrN coated

Super Micrograin Carbide

**Tolerance**

D 6,0 - 7,0 +0 / -0,025

D 8,0 - 9,0 +0 / -0,030

D 10,0 - 12,0 +0 / -0,035

**Shank**

Cylindrical h6, DIN6535 HA

**Flute**

50° right hand spiral, center cutting

**Field of application**

All types of steel up to HRC55

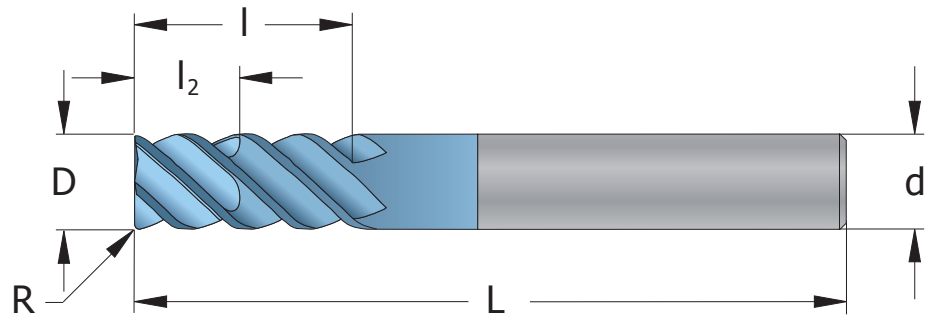

D mm	d mm	R mm	Part Number	l mm	l <sub>2</sub> mm	L mm	No. of Flutes
6,0	6	0,4	MV0606D16_LC	16	6	57	4
8,0	8	0,5	MV0808D20_LC	20	8	63	4
10,0	10	0,6	MV1010D25_LC	25	10	72	4
12,0	12	0,6	MV1212D30_LC	30	12	83	4

## Slot Milling and Side Milling with One Tool

Good chip removal for slot milling and strong and vibrationfree machining for side milling. Slot Side End Mills are engineered for precise slotting and side milling tasks in various materials. Their design ensures a clean and accurate cut, providing both depth control and minimized vibration. Ideal for jobs requiring defined slots or recesses, these tools offer reliability and consistency, enhancing your machining operations' precision and productivity.





## Wave formed, Roughing, Three Flute

**LC**  
 AlCrN coated  
 Super Micrograin Carbide  
**Tolerance**  
 D 6,0 - 7,0 +0 / -0,025  
 D 8,0 - 9,0 +0 / -0,030  
 D 10,0 - 12,0 +0 / -0,035  
**Shank**  
 Cylindrical h6, DIN6535 HA  
**Flute**  
 35° right hand spiral, center cutting  
**Field of application**  
 All types of steel up to HRC55

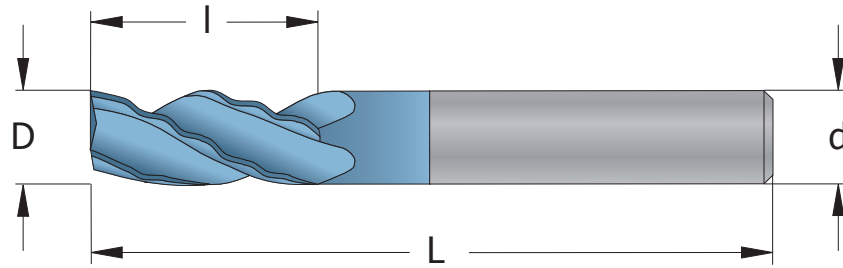

D mm	d mm	Part Number	l mm	L mm	No. of Flutes
6,0	6	FW0606C16_LC	16	57	3
8,0	8	FW0808C20_LC	20	63	3
10,0	10	FW1010C25_LC	25	72	3
12,0	12	FW1212C30_LC	30	83	3

### Wave Formed End Mills: Roughing Redefined

Wave formed Roughing End Mills are specifically crafted for high feed rates in roughing applications. Their wave-like profile optimizes chip formation and ejection, resulting in reduced power consumption, minimized cutting forces, and enhanced tool life. Suited for various materials, these tools provide an effective solution for large material removal, ensuring precise and efficient roughing operations.



*Wave formed cutting edge gives high productivity*

## Wave formed, Roughing, Four Flute

**LC**

AlCrN coated

Super Micrograin Carbide

**Tolerance**

D 6,0 - 7,0 +0 / -0,025

D 8,0 - 9,0 +0 / -0,030

D 10,0 - 12,0 +0 / -0,035

**Shank**

Cylindrical h6, DIN6535 HA

**Flute**

35° right hand spiral, center cutting

**Field of application**

All types of steel up to HRC55

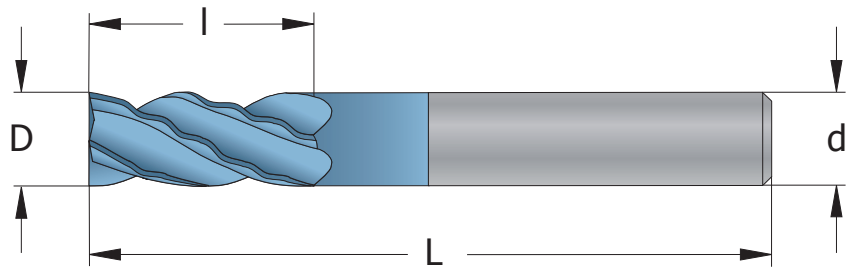

D mm	d mm	Part Number	l mm	L mm	No. of Flutes
6,0	6	FW0606D16_LC	16	57	4
8,0	8	FW0808D20_LC	20	63	4
10,0	10	FW1010D25_LC	25	72	4
12,0	12	FW1212D30_LC	30	83	4

## Two Flute, for aluminium

**MG**  
 Uncoated  
 Super Micrograin Carbide  
**Tolerance**  
 D 1,0 - 5,0 +0 / -0,020  
 D 6,0 - 7,0 +0 / -0,025  
 D 8,0 - 9,0 +0 / -0,030  
 D 10,0 - 12,0 +0 / -0,035  
**Shank**  
 Cylindrical h6, DIN6535 HA  
**Flute**  
 45° right hand spiral, center cutting  
**Field of application**  
 Aluminium

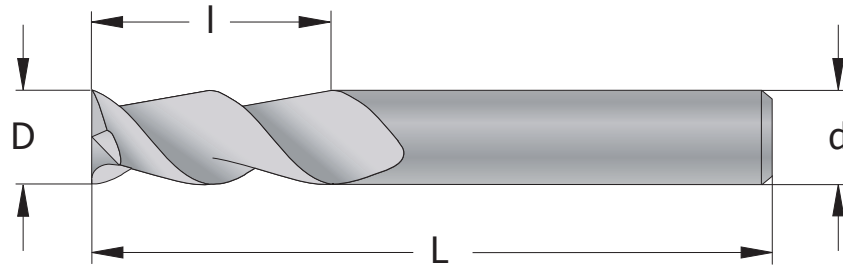

D mm	d mm	Part Number	l mm	L mm	No. of Flutes
2,0	6	MA0602B6_MG	6	57	2
3,0	6	MA0603B8_MG	8	57	2
4,0	6	MA0604B11_MG	11	57	2
5,0	6	MA0605B13_MG	13	57	2
6,0	6	MA0606B16_MG	16	57	2
8,0	8	MA0808B20_MG	20	63	2
10,0	10	MA1010B25_MG	25	72	2
12,0	12	MA1212B30_MG	30	83	2

### Solid Carbide End Mills for Aluminium

The flute and overall design of our aluminium end mills are tailored to the material's properties, allowing for high removal rates and extended tool life.

We offer a range of standard end mills for aluminium with 2 or 3 flutes and end mills for roughing in aluminium.



## Three Flute, for aluminium

**MG**

Uncoated

Super Micrograin Carbide

**Tolerance**

D 1,0 - 5,0 +0 / -0,020

D 6,0 - 7,0 +0 / -0,025

D 8,0 - 9,0 +0 / -0,030

D 10,0 - 12,0 +0 / -0,035

**Shank**

Cylindrical h6, DIN6535 HA

**Flute**

50° right hand spiral, center cutting

**Field of application**

Aluminium

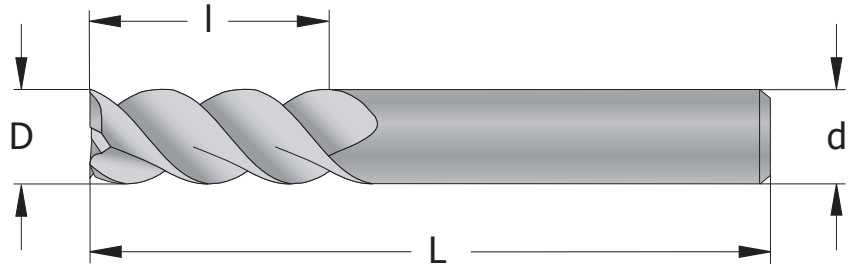

D mm	d mm	Part Number	l mm	L mm	No. of Flutes
2,0	6	MA0602C6_MG	6	57	3
3,0	6	MA0603C8_MG	8	57	3
4,0	6	MA0604C11_MG	11	57	3
5,0	6	MA0605C13_MG	13	57	3
6,0	6	MA0606C16_MG	16	57	3
8,0	8	MA0808C20_MG	20	63	3
10,0	10	MA1010C25_MG	25	72	3
12,0	12	MA1212C30_MG	30	83	3



## Wave formed, Roughing, for aluminium

**MG**  
 Uncoated  
 Super Micrograin Carbide  
**Tolerance**  
 D 6,0 - 7,0 +0 / -0,025  
 D 8,0 - 9,0 +0 / -0,030  
 D 10,0 - 12,0 +0 / -0,035  
**Shank**  
 Cylindrical h6, DIN6535 HA  
**Flute**  
 45° right hand spiral, center cutting  
**Field of application**  
 Aluminium

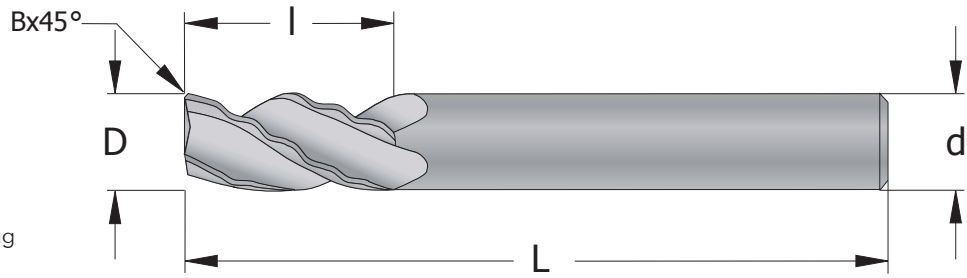

D mm	d mm	B mm	Part Number	l mm	L mm	No. of Flutes
6,0	6	0,2	FWA0606C16_MG	16	57	3
8,0	8	0,25	FWA0808C20_MG	20	63	3
10,0	10	0,3	FWA1010C25_MG	25	72	3
12,0	12	0,3	FWA1212C30_MG	30	83	3

*Small chamfer gives longer tool life*

*Deep flute for aluminium*

*Wave formed cutting edge gives high productivity*



## Two Flute

## FC

TiAlN coated

Micrograin Carbide

## Tolerance

D 1,0 - 25,0 +0 / -0,050

## Shank

Cylindrical with h6 tolerance

## Flute

30° right hand spiral, center cutting

## Field of application

All types of steel

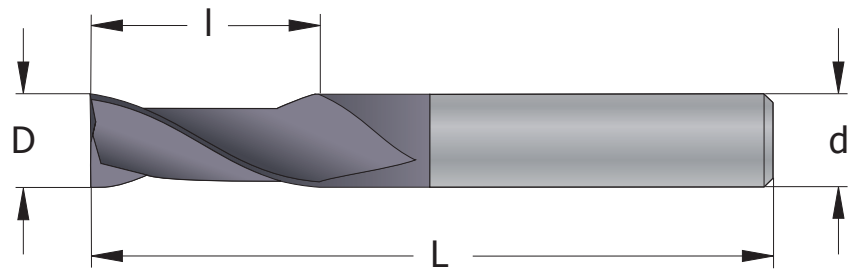

D mm	d mm	Part Number	l mm	L mm	No. of Flutes
1,0	3	M0301B3_FC	3	38	2
1,5	3	M03015B5_FC	5	38	2
2,0	3	M0302B6_FC	6	38	2
2,5	3	M03025B7_FC	7	38	2
3,0	3	M0303B12_FC	12	38	2
3,0	3	M0303B25_FC	25	65	2
3,5	4	M04035B12_FC	12	50	2
4,0	4	M0404B14_FC	14	50	2
4,0	4	M0404B25_FC	25	65	2
4,5	5	M05045B14_FC	14	50	2
5,0	5	M0505B16_FC	16	50	2
5,0	5	M0505B25_FC	25	75	2
6,0	6	M0606B19_FC	19	63	2
6,0	6	M0606B25_FC	25	75	2
6,0	6	M0606B38_FC	38	100	2
7,0	8	M0807B19_FC	19	63	2
8,0	8	M0808B19_FC	19	63	2
8,0	8	M0808B25_FC	25	75	2
8,0	8	M0808B38_FC	38	100	2
9,0	10	M1009B22_FC	22	70	2
10,0	10	M1010B22_FC	22	70	2
10,0	10	M1010B38_FC	38	100	2
12,0	12	M1212B25_FC	25	75	2
12,0	12	M1212B50_FC	50	100	2
12,0	12	M1212B75_FC	75	150	2
14,0	14	M1414B30_FC	30	88	2
14,0	14	M1414B75_FC	75	150	2
16,0	16	M1616B32_FC	32	88	2
16,0	16	M1616B75_FC	75	150	2
18,0	18	M1818B36_FC	36	100	2
20,0	20	M2020B38_FC	38	100	2
20,0	20	M2020B75_FC	75	150	2
25,0	25	M2525B38_FC	38	100	2
25,0	25	M2525B75_FC	75	150	2

## Solid Carbide End Mills with FC grade

Explore our large selection of FC end mills, they come in many different sizes and lengths. These end mills are also available with corner radius, ball nose, and high helix.

FC is an all-round grade that performs well in a wide range of materials and applications.

## Three Flute

**FC**  
 TiAlN coated  
 Micrograin Carbide  
**Tolerance**  
 D 1,0 - 25,0 +0 / -0,050  
**Shank**  
 Cylindrical with h6 tolerance  
**Flute**  
 30° right hand spiral, center cutting  
**Field of application**  
 All types of steel

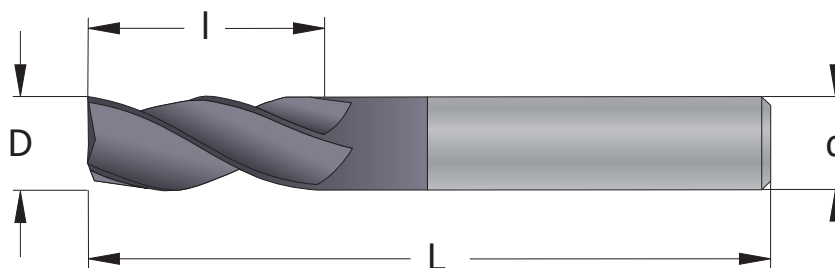

D mm	d mm	Part Number	l mm	L mm	No. of Flutes
1,0	3	M0301C3_FC	3	38	3
1,5	3	M03015C5_FC	5	38	3
2,0	3	M0302C6_FC	6	38	3
2,5	3	M03025C7_FC	7	38	3
3,0	3	M0303C12_FC	12	38	3
3,0	3	M0303C25_FC	25	65	3
3,5	4	M04035C12_FC	12	50	3
4,0	4	M0404C14_FC	14	50	3
4,0	4	M0404C25_FC	25	65	3
4,5	5	M05045C14_FC	14	50	3
5,0	5	M0505C16_FC	16	50	3
5,0	5	M0505C25_FC	25	75	3
6,0	6	M0606C19_FC	19	63	3
6,0	6	M0606C25_FC	25	75	3
7,0	8	M0807C19_FC	19	63	3
8,0	8	M0808C19_FC	19	63	3
8,0	8	M0808C25_FC	25	75	3
9,0	10	M1009C22_FC	22	70	3
10,0	10	M1010C22_FC	22	70	3
10,0	10	M1010C38_FC	38	100	3
12,0	12	M1212C25_FC	25	75	3
12,0	12	M1212C50_FC	50	100	3
14,0	14	M1414C30_FC	30	88	3
16,0	16	M1616C32_FC	32	88	3
16,0	16	M1616C75_FC	75	150	3
18,0	18	M1818C36_FC	36	100	3
20,0	20	M2020C38_FC	38	100	3
20,0	20	M2020C75_FC	75	150	3
25,0	25	M2525C38_FC	38	100	3
25,0	25	M2525C75_FC	75	150	3

## Four Flute

**FC**

TiAlN coated

Micrograin Carbide

**Tolerance**

D 1,0 - 25,0 +0 / -0,050

**Shank**

Cylindrical with h6 tolerance

**Flute**

30° right hand spiral, center cutting

**Field of application**

All types of steel

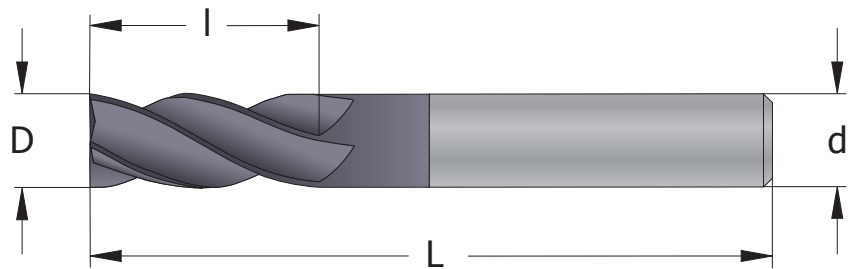

D mm	d mm	Part Number	l mm	L mm	No. of Flutes
1,0	3	M0301D3_FC	3	38	4
1,5	3	M03015D5_FC	5	38	4
2,0	3	M0302D6_FC	6	38	4
2,5	3	M03025D7_FC	7	38	4
3,0	3	M0303D12_FC	12	38	4
3,0	3	M0303D25_FC	25	65	4
3,5	4	M04035D12_FC	12	50	4
4,0	4	M0404D14_FC	14	50	4
4,0	4	M0404D25_FC	25	65	4
4,5	5	M05045D14_FC	14	50	4
5,0	5	M0505D16_FC	16	50	4
5,0	5	M0505D25_FC	25	75	4
6,0	6	M0606D19_FC	19	63	4
6,0	6	M0606D25_FC	25	75	4
6,0	6	M0606D38_FC	38	100	4
7,0	8	M0807D19_FC	19	63	4
8,0	8	M0808D19_FC	19	63	4
8,0	8	M0808D25_FC	25	75	4
8,0	8	M0808D38_FC	38	100	4
9,0	10	M1009D22_FC	22	70	4
10,0	10	M1010D22_FC	22	70	4
10,0	10	M1010D38_FC	38	100	4
12,0	12	M1212D25_FC	25	75	4
12,0	12	M1212D50_FC	50	100	4
12,0	12	M1212D75_FC	75	150	4
14,0	14	M1414D30_FC	30	88	4
14,0	14	M1414D75_FC	75	150	4
16,0	16	M1616D32_FC	32	88	4
16,0	16	M1616D75_FC	75	150	4
18,0	18	M1818D36_FC	36	100	4
20,0	20	M2020D38_FC	38	100	4
20,0	20	M2020D75_FC	75	150	4
25,0	25	M2525D38_FC	38	100	4
25,0	25	M2525D75_FC	75	150	4



## Two Flute, with Corner Radius

**FC**  
 TiAlN coated  
 Micrograin Carbide  
**Tolerance**  
 D 4,0 - 20,0 +0 / -0,050  
**Shank**  
 Cylindrical with h6 tolerance  
**Flute**  
 30° right hand spiral, center cutting  
**Field of application**  
 All types of steel

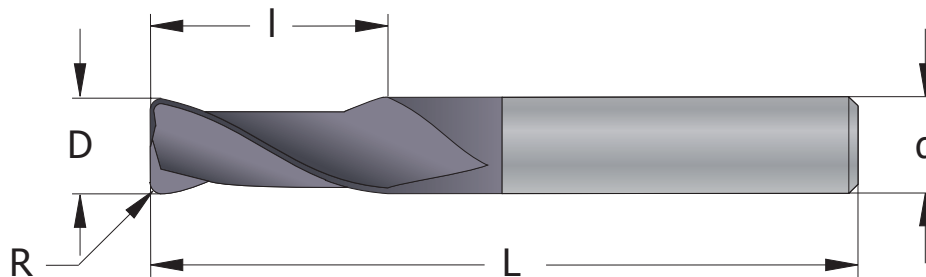

D mm	d mm	R mm	Part Number	l mm	L mm	No. of Flutes
4,0	4	0,25	M0404B14R025_FC	14	50	2
4,0	4	0,50	M0404B14R05_FC	14	50	2
4,0	4	0,75	M0404B14R075_FC	14	50	2
4,0	4	1,00	M0404B14R10_FC	14	50	2
6,0	6	0,25	M0606B19R025_FC	19	63	2
6,0	6	0,50	M0606B19R05_FC	19	63	2
6,0	6	0,75	M0606B19R075_FC	19	63	2
6,0	6	1,00	M0606B19R10_FC	19	63	2
6,0	6	1,25	M0606B19R125_FC	19	63	2
6,0	6	1,50	M0606B19R15_FC	19	63	2
8,0	8	0,50	M0808B19R05_FC	19	63	2
8,0	8	0,75	M0808B19R075_FC	19	63	2
8,0	8	1,00	M0808B19R10_FC	19	63	2
8,0	8	1,25	M0808B19R125_FC	19	63	2
8,0	8	1,50	M0808B19R15_FC	19	63	2
8,0	8	2,00	M0808B19R20_FC	19	63	2
10,0	10	0,50	M1010B22R05_FC	22	70	2
10,0	10	0,75	M1010B22R075_FC	22	70	2
10,0	10	1,00	M1010B22R10_FC	22	70	2
10,0	10	1,50	M1010B22R15_FC	22	70	2
10,0	10	2,00	M1010B22R20_FC	22	70	2
10,0	10	3,00	M1010B22R30_FC	22	70	2
12,0	12	0,50	M1212B25R05_FC	25	75	2
12,0	12	0,75	M1212B25R075_FC	25	75	2
12,0	12	1,00	M1212B25R10_FC	25	75	2
12,0	12	1,50	M1212B25R15_FC	25	75	2
12,0	12	2,00	M1212B25R20_FC	25	75	2
12,0	12	3,00	M1212B25R30_FC	25	75	2
16,0	16	0,50	M1616B32R05_FC	32	88	2
16,0	16	0,75	M1616B32R075_FC	32	88	2
16,0	16	1,00	M1616B32R10_FC	32	88	2
16,0	16	1,50	M1616B32R15_FC	32	88	2
16,0	16	2,00	M1616B32R20_FC	32	88	2
16,0	16	3,00	M1616B32R30_FC	32	88	2
20,0	20	0,50	M2020B38R05_FC	38	100	2
20,0	20	0,75	M2020B38R075_FC	38	100	2
20,0	20	1,00	M2020B38R10_FC	38	100	2
20,0	20	1,50	M2020B38R15_FC	38	100	2
20,0	20	2,00	M2020B38R20_FC	38	100	2
20,0	20	3,00	M2020B38R30_FC	38	100	2

## Four Flute, with Corner Radius

**FC**

TiAlN coated

Micrograin Carbide

**Tolerance**

D 4,0 - 20,0 +0 / -0,050

**Shank**

Cylindrical with h6 tolerance

**Flute**

30° right hand spiral, center cutting

**Field of application**

All types of steel

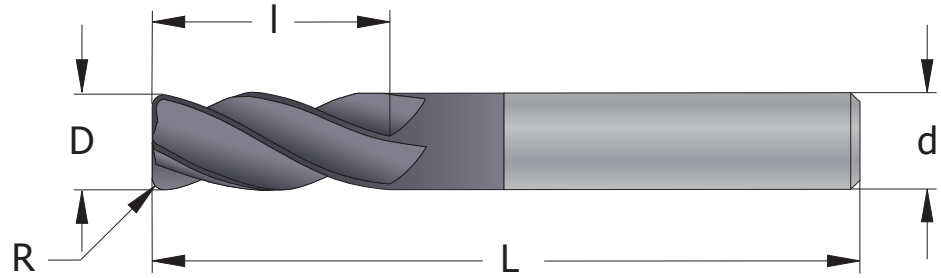

D mm	d mm	R mm	Part Number	l mm	L mm	No. of Flutes
4,0	4	0,25	M0404D14R025_FC	14	50	4
4,0	4	0,50	M0404D14R05_FC	14	50	4
4,0	4	0,75	M0404D14R075_FC	14	50	4
4,0	4	1,00	M0404D14R10_FC	14	50	4
6,0	6	0,25	M0606D19R025_FC	19	63	4
6,0	6	0,50	M0606D19R05_FC	19	63	4
6,0	6	0,75	M0606D19R075_FC	19	63	4
6,0	6	1,00	M0606D19R10_FC	19	63	4
6,0	6	1,25	M0606D19R125_FC	19	63	4
6,0	6	1,50	M0606D19R15_FC	19	63	4
8,0	8	0,50	M0808D19R05_FC	19	63	4
8,0	8	0,75	M0808D19R075_FC	19	63	4
8,0	8	1,00	M0808D19R10_FC	19	63	4
8,0	8	1,25	M0808D19R125_FC	19	63	4
8,0	8	1,50	M0808D19R15_FC	19	63	4
8,0	8	2,00	M0808D19R20_FC	19	63	4
10,0	10	0,50	M1010D22R05_FC	22	70	4
10,0	10	0,75	M1010D22R075_FC	22	70	4
10,0	10	1,00	M1010D22R10_FC	22	70	4
10,0	10	1,50	M1010D22R15_FC	22	70	4
10,0	10	2,00	M1010D22R20_FC	22	70	4
10,0	10	3,00	M1010D22R30_FC	22	70	4
12,0	12	0,50	M1212D25R05_FC	25	75	4
12,0	12	0,75	M1212D25R075_FC	25	75	4
12,0	12	1,00	M1212D25R10_FC	25	75	4
12,0	12	1,50	M1212D25R15_FC	25	75	4
12,0	12	2,00	M1212D25R20_FC	25	75	4
12,0	12	3,00	M1212D25R30_FC	25	75	4
16,0	16	0,50	M1616D32R05_FC	32	88	4
16,0	16	0,75	M1616D32R075_FC	32	88	4
16,0	16	1,00	M1616D32R10_FC	32	88	4
16,0	16	1,50	M1616D32R15_FC	32	88	4
16,0	16	2,00	M1616D32R20_FC	32	88	4
16,0	16	3,00	M1616D32R30_FC	32	88	4
20,0	20	0,50	M2020D38R05_FC	38	100	4
20,0	20	0,75	M2020D38R075_FC	38	100	4
20,0	20	1,00	M2020D38R10_FC	38	100	4
20,0	20	1,50	M2020D38R15_FC	38	100	4
20,0	20	2,00	M2020D38R20_FC	38	100	4
20,0	20	3,00	M2020D38R30_FC	38	100	4

## Two Flute, with Ball Nose

**FC**  
TiAlN coated  
Micrograin Carbide  
**Tolerance**  
D 1,0 - 25,0 +0 / -0,050  
**Shank**  
Cylindrical with h6 tolerance  
**Flute**  
30° right hand spiral  
**Field of application**  
All types of steel

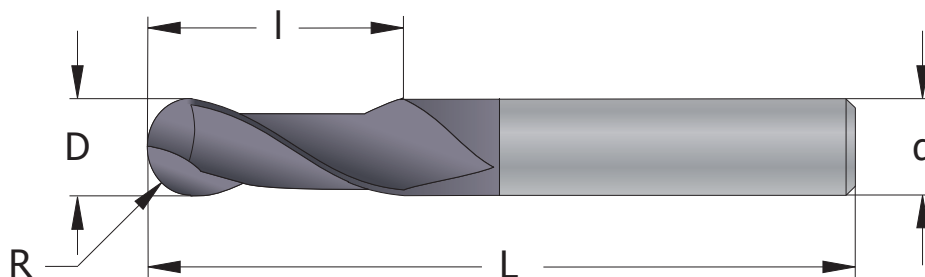

D mm	d mm	R mm	Part Number	l mm	L mm	No. of Flutes
1,0	3	0,50	R0301B3_FC	3	38	2
1,5	3	0,75	R03015B5_FC	5	38	2
2,0	3	1,00	R0302B6_FC	6	38	2
2,5	3	1,25	R03025B7_FC	7	38	2
3,0	3	1,50	R0303B12_FC	12	38	2
3,0	3	1,50	R0303B25_FC	25	65	2
4,0	4	2,00	R0404B14_FC	14	50	2
4,0	4	2,00	R0404B25_FC	25	65	2
5,0	5	2,50	R0505B16_FC	16	50	2
5,0	5	2,50	R0505B25_FC	25	75	2
6,0	6	3,00	R0606B19_FC	19	63	2
6,0	6	3,00	R0606B25_FC	25	75	2
6,0	6	3,00	R0606B38_FC	38	100	2
8,0	8	4,00	R0808B19_FC	19	63	2
8,0	8	4,00	R0808B25_FC	25	75	2
8,0	8	4,00	R0808B38_FC	38	100	2
10,0	10	5,00	R1010B22_FC	22	70	2
10,0	10	5,00	R1010B38_FC	38	100	2
12,0	12	6,00	R1212B25_FC	25	75	2
12,0	12	6,00	R1212B50_FC	50	100	2
12,0	12	6,00	R1212B75_FC	75	150	2
14,0	14	7,00	R1414B30_FC	30	88	2
16,0	16	8,00	R1616B32_FC	32	88	2
16,0	16	8,00	R1616B75_FC	75	150	2
18,0	18	9,00	R1818B36_FC	36	100	2
20,0	20	10,0	R2020B38_FC	38	100	2
20,0	20	10,0	R2020B75_FC	75	150	2
25,0	25	12,5	R2525B75_FC	75	150	2

## with Long Shank

D mm	d mm	R mm	Part Number	l mm	L mm	No. of Flutes
2,0	2	1,0	R0202B10L100_FC	10	100	2
3,0	3	1,5	R0303B12L100_FC	12	100	2
4,0	4	2,0	R0404B15L120_FC	15	120	2
5,0	5	2,5	R0505B15L150_FC	15	150	2
6,0	6	3,0	R0606B20L150_FC	20	150	2
8,0	8	4,0	R0808B20L180_FC	20	180	2
10,0	10	5,0	R1010B25L200_FC	25	200	2
12,0	12	6,0	R1212B30L200_FC	30	200	2

## Four Flute, with Ball Nose

**FC**

TiAlN coated

Micrograin Carbide

**Tolerance**

D 1,0 - 25,0 +0 / -0,050

**Shank**

Cylindrical with h6 tolerance

**Flute**

30° right hand spiral

**Field of application**

All types of steel

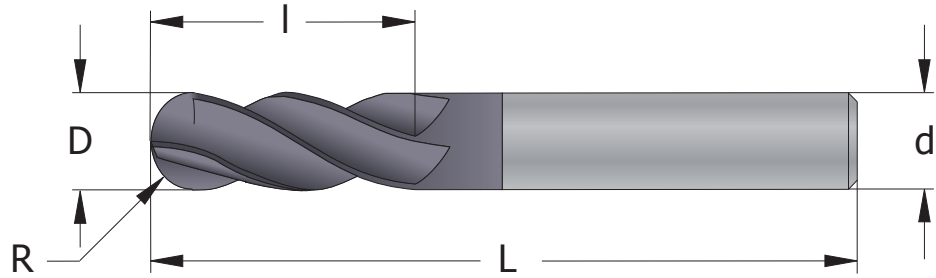

D mm	d mm	R mm	Part Number	l mm	L mm	No. of Flutes
1,0	3	0,50	R0301D3_FC	3	38	4
1,5	3	0,75	R03015D5_FC	5	38	4
2,0	3	1,00	R0302D6_FC	6	38	4
2,5	3	1,25	R03025D7_FC	7	38	4
3,0	3	1,50	R0303D12_FC	12	38	4
3,0	3	1,50	R0303D25_FC	25	65	4
4,0	4	2,00	R0404D14_FC	14	50	4
4,0	4	2,00	R0404D25_FC	25	65	4
5,0	5	2,50	R0505D16_FC	16	50	4
5,0	5	2,50	R0505D25_FC	25	75	4
6,0	6	3,00	R0606D19_FC	19	63	4
6,0	6	3,00	R0606D25_FC	25	75	4
6,0	6	3,00	R0606D38_FC	38	100	4
8,0	8	4,00	R0808D19_FC	19	63	4
8,0	8	4,00	R0808D25_FC	25	75	4
8,0	8	4,00	R0808D38_FC	38	100	4
10,0	10	5,00	R1010D22_FC	22	70	4
10,0	10	5,00	R1010D38_FC	38	100	4
12,0	12	6,00	R1212D25_FC	25	75	4
12,0	12	6,00	R1212D50_FC	50	100	4
12,0	12	6,00	R1212D75_FC	75	150	4
14,0	14	7,00	R1414D30_FC	30	88	4
16,0	16	8,00	R1616D32_FC	32	88	4
16,0	16	8,00	R1616D75_FC	75	150	4
18,0	18	9,00	R1818D36_FC	36	100	4
20,0	20	10,0	R2020D38_FC	38	100	4
20,0	20	10,0	R2020D75_FC	75	150	4
25,0	25	12,5	R2525D75_FC	75	150	4

## High Helix

FC  
TiAlN coated  
Micrograin Carbide  
**Tolerance**  
D 10,0 - 32,0 +0 / -0,050  
**Shank**  
Cylindrical h6, DIN6535 HA  
**Flute**  
50° right hand spiral

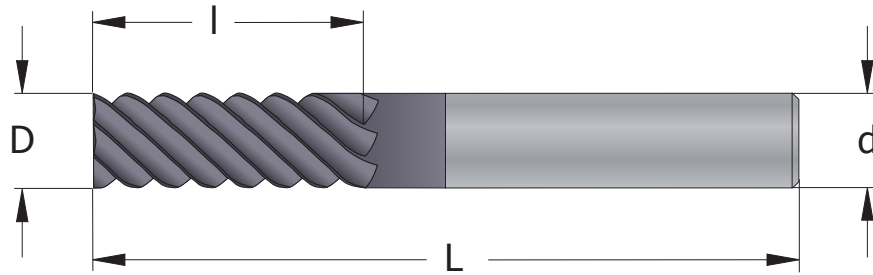

### for Soft Materials

D mm	d mm	Part Number	l mm	L mm	No. of Flutes
10,0	10	U1010F25_FC	25	76	6
12,0	12	U1212F30_FC	30	83	6
16,0	16	U1616F40_FC	40	100	6
20,0	20	U2020F45_FC	45	120	6
25,0	25	U2525F60_FC	60	130	6

### for Hard Materials

D mm	d mm	Part Number	l mm	L mm	No. of Flutes
6,0	6	V0606F15_FC	15	63	6
8,0	8	V0808F20_FC	20	76	6
10,0	10	V1010F25_FC	25	76	6
12,0	12	V1212F30_FC	30	83	6
16,0	16	V1616F40_FC	40	100	6
20,0	20	V2020F45_FC	45	120	6
25,0	25	V2525H60_FC	60	130	8

## High Helix End Mills: For Efficient Machining

High Helix End Mills are extremely efficient tools for side milling. The high angle of these end mills aids in effective chip evacuation, reducing heat and minimizing tool wear. Ideal for both high-speed machining and achieving fine surface finishes, these tools deliver precision and productivity in a variety of applications.

The V-type end mill features a special geometry for efficient machining in hardened steel. For other types of steel, choose the U-type end mill.



## Roughing End Mill

## FC

TiAlN coated

Super Micrograin Carbide

## Tolerance

D 1,0 - 3,0 -0,002 / -0,012

D 4,0 - 6,0 -0,004 / -0,016

D 7,0 - 10,0 -0,005 / -0,020

D 11,0 - 18,0 -0,006 / -0,024

## Shank

Cylindrical h5, DIN6535 HA

## Flute

45° right hand spiral, center cutting

## Field of application

All types of steel

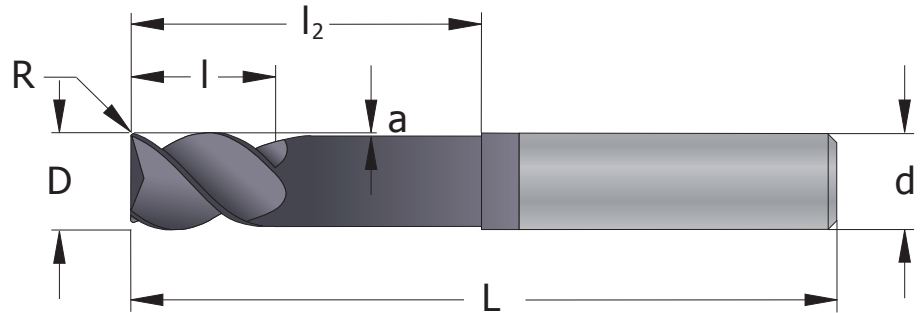

D mm	d mm	R mm	Part Number	l mm	l <sub>2</sub> mm	L mm	a mm	No. of Flutes
3,0	3	0,2	TH0303C4_FC	4	10	39	0,05	3
5,0	6	0,2	TH0605C6_FC	6	14	64	0,15	3
6,0	6	0,3	TH0606C7_FC	7	16	64	0,2	3
8,0	8	0,5	TH0808C9_FC	9	20	64	0,3	3
10,0	10	0,5	TH1010C12_FC	12	25	70	0,3	3
12,0	12	0,5	TH1212C15_FC	15	30	78	0,3	3
16,0	16	0,5	TH1616C18_FC	18	38	89	0,3	3

Achieve high material removal  
with its outstanding chip flow.

Waist design ensures  
reach into deep areas.



## Micro, Two Flute

**FC**  
TiAlN coated  
Super Micrograin Carbide  
**Tolerance**  
D 0,3 - 3,0 -0,002 / -0,012  
**Shank**  
Cylindrical h5, DIN6535 HA  
**Flute**  
30° right hand spiral, center cutting  
**Field of application**  
High speed cutting in steel

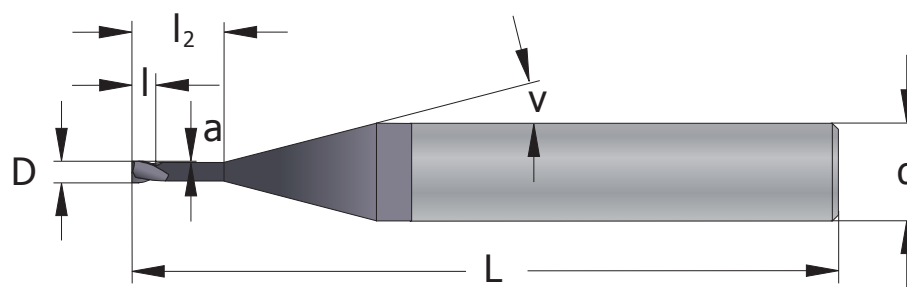

D mm	d mm	Part Number	l mm	l <sub>2</sub> mm	L mm	a mm	v °	No. of Flutes
0,1	6	MP06001B0.2_FC	0,15	0,15	64		10	2
0,2	6	MP06002B0.3_FC	0,3	0,3	64		10	2
0,3	6	MP06003B0.5_FC	0,5	0,5	64		11	2
0,3	6	MP06003B0.6_FC	0,5	1,5	64	0,010	11	2
0,3	6	MP06003B0.7_FC	0,5	3,0	64	0,010	12	2
0,4	6	MP06004B0.7_FC	0,6	0,6	64		11	2
0,4	6	MP06004B0.8_FC	0,6	2,0	64	0,010	11	2
0,4	6	MP06004B0.9_FC	0,6	4,0	64	0,010	13	2
0,5	6	MP06005B0.9_FC	0,8	0,8	64		11	2
0,5	6	MP06005B1_FC	0,8	3,0	64	0,015	12	2
0,5	6	MP06005B1.1_FC	0,8	6,0	64	0,015	15	2
0,5	6	MP06005B1.2_FC	0,8	8,0	64	0,015	15	2
0,5	6	MP06005B1.3_FC	0,8	10,0	64	0,015	15	2
0,6	6	MP06006B1.1_FC	0,9	0,9	64		10	2
0,6	6	MP06006B1.15_FC	0,9	2,0	64	0,025	11	2
0,6	6	MP06006B1.2_FC	0,9	4,0	64	0,025	13	2
0,6	6	MP06006B1.3_FC	0,9	6,0	64	0,025	15	2
0,6	6	MP06006B1.4_FC	0,9	8,0	64	0,025	15	2
0,6	6	MP06006B1.5_FC	0,9	10,0	64	0,025	15	2
0,8	6	MP06008B1.5_FC	1,2	1,2	64		10	2
0,8	6	MP06008B1.55_FC	1,2	2,5	64	0,025	11	2
0,8	6	MP06008B1.6_FC	1,2	5,0	64	0,025	13	2
0,8	6	MP06008B1.7_FC	1,2	8,0	64	0,025	15	2
0,8	6	MP06008B1.8_FC	1,2	10,0	64	0,025	15	2
1,0	6	MP0601B1.9_FC	1,5	1,5	64		10	2
1,0	6	MP0601B1.95_FC	1,5	4,0	64	0,025	12	2
1,0	6	MP0601B2_FC	1,5	6,0	64	0,025	14	2
1,0	6	MP0601B2.1_FC	1,5	10,0	64	0,025	15	2
1,0	6	MP0601B2.2_FC	1,5	15,0	64	0,025	15	2
1,0	6	MP0601B2.3_FC	1,5	20,0	64	0,025	15	2
1,0	6	MP0601B2.4_FC	1,5	25,0	64	0,025	15	2
1,2	6	MP06012B2.3_FC	1,8	1,8	64		10	2
1,2	6	MP06012B2.34_FC	1,8	4,0	64	0,025	11	2
1,2	6	MP06012B2.37_FC	1,8	6,0	64	0,025	14	2
1,2	6	MP06012B2.4_FC	1,8	8,0	64	0,025	15	2
1,2	6	MP06012B2.5_FC	1,8	12,0	64	0,025	15	2
1,2	6	MP06012B2.6_FC	1,8	16,0	64	0,025	15	2
1,5	6	MP06015B2.9_FC	2,3	2,3	64		10	2
1,5	6	MP06015B2.95_FC	2,3	6,0	64	0,025	13	2
1,5	6	MP06015B3_FC	2,3	10,0	64	0,025	15	2
1,5	6	MP06015B3.1_FC	2,3	15,0	64	0,025	15	2
1,5	6	MP06015B3.2_FC	2,3	20,0	64	0,025	15	2
1,5	6	MP06015B3.3_FC	2,3	25,0	64	0,025	15	2
2,0	6	MP0602B2.9_FC	3,0	3,0	64		9	2
2,0	6	MP0602B2.95_FC	3,0	6,0	64	0,05	11	2

continue

## Micro, Two Flute

D mm	d mm	Part Number	l mm	l <sub>2</sub> mm	L mm	a mm	ν °	No. of Flutes
2,0	6	MP0602B3_FC	3,0	10,0	64	0,05	15	2
2,0	6	MP0602B3.1_FC	3,0	16,0	64	0,05	15	2
2,0	6	MP0602B3.2_FC	3,0	20,0	64	0,05	15	2
2,0	6	MP0602B3.3_FC	3,0	25,0	64	0,05	15	2
2,0	6	MP0602B3.4_FC	3,0	30,0	64	0,05	15	2
2,5	6	MP06025B2.9_FC	3,0	3,0	64		8	2
2,5	6	MP06025B2.95_FC	3,0	6,0	64	0,05	10	2
2,5	6	MP06025B3_FC	3,0	10,0	64	0,05	15	2
2,5	6	MP06025B3.1_FC	3,0	16,0	64	0,05	15	2
2,5	6	MP06025B3.2_FC	3,0	20,0	64	0,05	15	2
2,5	6	MP06025B3.3_FC	3,0	25,0	64	0,05	15	2
3,0	6	MP0603B2.9_FC	3,0	3,0	64		7	2
3,0	6	MP0603B2.95_FC	3,0	6,0	64	0,05	9	2
3,0	6	MP0603B3_FC	3,0	10,0	64	0,05	14	2
3,0	6	MP0603B3.1_FC	3,0	16,0	64	0,05	15	2
3,0	6	MP0603B3.2_FC	3,0	20,0	64	0,05	15	2
3,0	6	MP0603B3.3_FC	3,0	25,0	64	0,05	15	2
3,0	6	MP0603B3.4_FC	3,0	30,0	64	0,05	15	2

■ Micro End Mills are available with Corner Radius. The price is 10% higher.

## Mold and Die End Mills: High-Speed Cutting Solutions

SmiCut offers an extensive range of Mold and Die End Mills, designed for high-speed cutting applications. Our collection includes Micro End Mills as small as Ø0.1 mm, end mills with corner radius, ball nose options, and more. Many of these end mills are also available with a durable diamond coating for enhanced performance.





## Micro, Two Flute, with Ball Nose

**FC**  
 TiAlN coated  
 Super Micrograin Carbide  
**Tolerance**  
 D 0,3 - 3,0 -0,002 / -0,012  
**Shank**  
 Cylindrical h5, DIN6535 HA  
**Flute**  
 30° right hand spiral  
**Field of application**  
 High speed cutting in steel

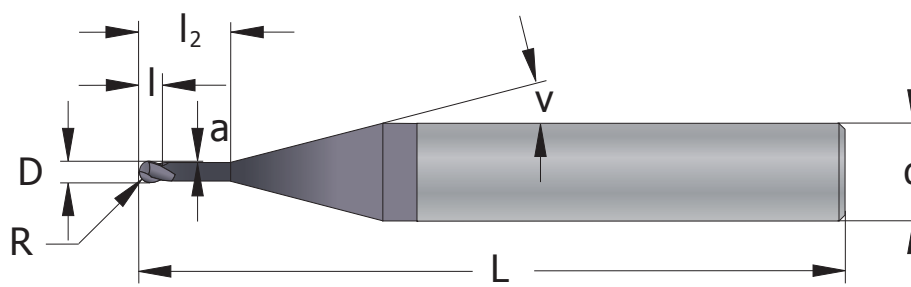

D mm	d mm	R mm	Part Number	l mm	l <sub>2</sub> mm	L mm	a mm	v °	No. of Flutes
0,2	6	0,10	RP06002B0.3_FC	0,3	0,3	64		10	2
0,3	6	0,15	RP06003B0.5_FC	0,5	0,5	64		11	2
0,3	6	0,15	RP06003B0.6_FC	0,5	1,5	64	0,010	11	2
0,3	6	0,15	RP06003B0.7_FC	0,5	3,0	64	0,010	12	2
0,4	6	0,2	RP06004B0.7_FC	0,6	0,6	64		11	2
0,4	6	0,2	RP06004B0.8_FC	0,6	2,0	64	0,010	11	2
0,4	6	0,2	RP06004B0.9_FC	0,6	4,0	64	0,010	13	2
0,5	6	0,25	RP06005B0.9_FC	0,8	0,8	64		11	2
0,5	6	0,25	RP06005B1_FC	0,8	3,0	64	0,015	12	2
0,5	6	0,25	RP06005B1.1_FC	0,8	6,0	64	0,015	15	2
0,5	6	0,25	RP06005B1.2_FC	0,8	8,0	64	0,015	15	2
0,5	6	0,25	RP06005B1.3_FC	0,8	10,0	64	0,015	15	2
0,6	6	0,3	RP06006B1.1_FC	0,9	0,9	64		10	2
0,6	6	0,3	RP06006B1.15_FC	0,9	2,0	64	0,025	11	2
0,6	6	0,3	RP06006B1.2_FC	0,9	4,0	64	0,025	13	2
0,6	6	0,3	RP06006B1.3_FC	0,9	6,0	64	0,025	15	2
0,6	6	0,3	RP06006B1.4_FC	0,9	8,0	64	0,025	15	2
0,6	6	0,3	RP06006B1.5_FC	0,9	10,0	64	0,025	15	2
0,8	6	0,4	RP06008B1.5_FC	1,2	1,2	64		10	2
0,8	6	0,4	RP06008B1.55_FC	1,2	2,5	64	0,025	11	2
0,8	6	0,4	RP06008B1.6_FC	1,2	5,0	64	0,025	13	2
0,8	6	0,4	RP06008B1.7_FC	1,2	8,0	64	0,025	15	2
0,8	6	0,4	RP06008B1.8_FC	1,2	10,0	64	0,025	15	2
1,0	6	0,5	RP0601B1.9_FC	1,5	1,5	64		10	2
1,0	6	0,5	RP0601B1.95_FC	1,5	4,0	64	0,025	12	2
1,0	6	0,5	RP0601B2_FC	1,5	6,0	64	0,025	14	2
1,0	6	0,5	RP0601B2.1_FC	1,5	10,0	64	0,025	15	2
1,0	6	0,5	RP0601B2.2_FC	1,5	15,0	64	0,025	15	2
1,0	6	0,5	RP0601B2.3_FC	1,5	20,0	64	0,025	15	2
1,0	6	0,5	RP0601B2.4_FC	1,5	25,0	64	0,025	15	2
1,2	6	0,6	RP06012B2.3_FC	1,8	1,8	64		10	2
1,2	6	0,6	RP06012B2.34_FC	1,8	4,0	64	0,025	11	2
1,2	6	0,6	RP06012B2.37_FC	1,8	6,0	64	0,025	14	2
1,2	6	0,6	RP06012B2.4_FC	1,8	8,0	64	0,025	15	2
1,2	6	0,6	RP06012B2.5_FC	1,8	12,0	64	0,025	15	2
1,2	6	0,6	RP06012B2.6_FC	1,8	16,0	64	0,025	15	2
1,5	6	0,75	RP06015B2.9_FC	2,3	2,3	64		10	2
1,5	6	0,75	RP06015B2.95_FC	2,3	6,0	64	0,025	13	2
1,5	6	0,75	RP06015B3_FC	2,3	10,0	64	0,025	15	2
1,5	6	0,75	RP06015B3.1_FC	2,3	15,0	64	0,025	15	2
1,5	6	0,75	RP06015B3.2_FC	2,3	20,0	64	0,025	15	2
1,5	6	0,75	RP06015B3.3_FC	2,3	25,0	64	0,025	15	2
2,0	6	1,0	RP0602B2.9_FC	3,0	3,0	64		9	2
2,0	6	1,0	RP0602B2.95_FC	3,0	6,0	64	0,05	11	2
2,0	6	1,0	RP0602B3_FC	3,0	10,0	64	0,05	15	2

D mm	d mm	R mm	Part Number	l mm	l <sub>2</sub> mm	L mm	a mm	v °	No. of Flutes
2,0	6	1,0	RP0602B3.1_FC	3,0	16,0	64	0,05	15	2
2,0	6	1,0	RP0602B3.2_FC	3,0	20,0	64	0,05	15	2
2,0	6	1,0	RP0602B3.3_FC	3,0	25,0	64	0,05	15	2
2,0	6	1,0	RP0602B3.4_FC	3,0	30,0	64	0,05	15	2
2,5	6	1,25	RP06025B2.9_FC	3,0	3,0	64		8	2
2,5	6	1,25	RP06025B2.95_FC	3,0	6,0	64	0,05	10	2
2,5	6	1,25	RP06025B3_FC	3,0	10,0	64	0,05	15	2
2,5	6	1,25	RP06025B3.1_FC	3,0	16,0	64	0,05	15	2
2,5	6	1,25	RP06025B3.2_FC	3,0	20,0	64	0,05	15	2
2,5	6	1,25	RP06025B3.3_FC	3,0	25,0	64	0,05	15	2
3,0	6	1,5	RP0603B2.9_FC	3,0	3,0	64		7	2
3,0	6	1,5	RP0603B2.95_FC	3,0	6,0	64	0,05	9	2
3,0	6	1,5	RP0603B3_FC	3,0	10,0	64	0,05	14	2
3,0	6	1,5	RP0603B3.1_FC	3,0	16,0	64	0,05	15	2
3,0	6	1,5	RP0603B3.2_FC	3,0	20,0	64	0,05	15	2
3,0	6	1,5	RP0603B3.3_FC	3,0	25,0	64	0,05	15	2
3,0	6	1,5	RP0603B3.4_FC	3,0	30,0	64	0,05	15	2

## Two Flute, with Corner Radius

FC  
TiAlN coated  
Super Micrograin Carbide  
**Tolerance**  
D 1,0 - 3,0 -0,002 / -0,012  
D 4,0 - 6,0 -0,004 / -0,016  
D 7,0 - 10,0 -0,005 / -0,020  
D 11,0 - 18,0 -0,006 / -0,024  
**Shank**  
Cylindrical h5, DIN6535 HA  
**Flute**  
30° right hand spiral, center cutting  
**Field of application**  
High speed cutting in steel

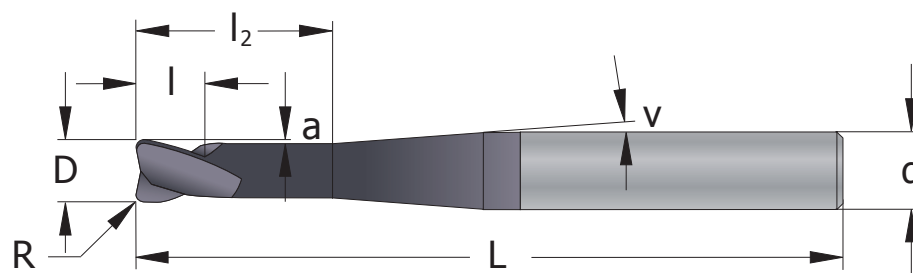

D mm	d mm	R mm	Part Number	l mm	l <sub>2</sub> mm	L mm	a mm	v °	No. of Flutes
1,5	6	0,3	MH06015B2R03L64_FC	2	5	64	0,05	7,0	2
1,5	6	0,3	MH06015B2.1R03L64_FC	2	10	64	0,05	9,0	2
2,0	6	0,5	MH0602B3R05L64_FC	3	5	64	0,05	6,0	2
2,0	6	0,5	MH0602B3.1R05L64_FC	3	10	64	0,05	8,0	2
2,0	6	0,5	MH0602B3R05L78_FC	3	15	78	0,05	5,0	2
3,0	6	0,5	MH0603B4R05L64_FC	4	7	64	0,05	5,0	2
3,0	6	0,5	MH0603B4R05L78_FC	4	15	78	0,05	4,0	2
4,0	6	0,5	MH0604B5R05L64_FC	5	8	64	0,1	4,0	2
4,0	6	0,5	MH0604B5R05L78_FC	5	15	78	0,1	2,5	2
4,0	6	1,0	MH0604B5R10L64_FC	5	8	64	0,1	4,0	2
4,0	6	1,0	MH0604B5R10L78_FC	5	15	78	0,1	2,5	2
5,0	6	0,5	MH0605B5R05L64_FC	5	10	64	0,15	2,5	2
5,0	6	0,5	MH0605B5R05L78_FC	5	20	78	0,15	2,0	2
5,0	6	1,0	MH0605B5R10L64_FC	5	10	64	0,15	2,5	2
5,0	6	1,0	MH0605B5R10L78_FC	5	20	78	0,15	2,0	2
6,0	6	0,5	MH0606B6R05L64_FC	6	25	64	0,2		2
6,0	6	0,5	MH0606B6R05L78_FC	6	35	78	0,2		2
6,0	8	0,5	MH0806B6R05L100_FC	6	25	100	0,2	2,0	2
6,0	6	1,0	MH0606B6R10L64_FC	6	25	64	0,2		2
6,0	6	1,0	MH0606B6R10L78_FC	6	35	78	0,2		2
6,0	8	1,0	MH0806B6R10L100_FC	6	25	100	0,2		2
6,0	6	1,5	MH0606B6R15L64_FC	6	25	64	0,2		2
6,0	6	1,5	MH0606B6R15L78_FC	6	35	78	0,2		2
6,0	8	1,5	MH0806B6R15L100_FC	6	25	100	0,2	2,0	2
8,0	8	0,5	MH0808B8R05L64_FC	8	25	64	0,3		2
8,0	8	0,5	MH0808B8R05L78_FC	8	25	78	0,3		2
8,0	8	1,0	MH0808B8R10L64_FC	8	25	64	0,3		2
8,0	8	1,0	MH0808B8R10L78_FC	8	35	78	0,3		2
8,0	8	1,0	MH0808B8R10L100_FC	8	50	100	0,3		2
8,0	8	2,0	MH0808B8R20L64_FC	8	25	64	0,3		2
8,0	8	2,0	MH0808B8R20L78_FC	8	35	78	0,3		2
8,0	8	2,0	MH0808B8R20L100_FC	8	50	100	0,3		2
8,0	10	1,0	MH1008B8R10L120_FC	8	30	120	0,3	1,5	2
8,0	10	2,0	MH1008B8R20L120_FC	8	30	120	0,3	1,5	2
10,0	10	0,5	MH1010B10R05L78_FC	10	35	78	0,3		2
10,0	10	1,0	MH1010B10R10L100_FC	10	55	100	0,3		2
10,0	10	2,0	MH1010B10R20L78_FC	10	35	78	0,3		2
10,0	10	2,0	MH1010B10R20L100_FC	10	55	100	0,3		2
10,0	12	2,0	MH1210B10R20L120_FC	10	30	120	0,3	1,5	2
12,0	12	0,5	MH1212B12R05L78_FC	12	35	78	0,3		2
12,0	12	1,0	MH1212B12R10L100_FC	12	55	100	0,3		2
12,0	12	2,0	MH1212B12R20L78_FC	12	35	78	0,3		2
12,0	12	2,0	MH1212B12R20L100_FC	12	55	100	0,3		2
12,0	16	2,0	MH1612B12R20L120_FC	12	40	120	0,3	4,5	2
16,0	16	3,5	MH1616B20R35L100_FC	20	50	100	0,3		2
16,0	16	3,5	MH1616B20R35L150_FC	20	100	150	0,3		2

## Four Flute, with Corner Radius

## FC

TiAlN coated

Super Micrograin Carbide

## Tolerance

D 1,0 - 3,0 -0,002 / -0,012

D 4,0 - 6,0 -0,004 / -0,016

D 7,0 - 10,0 -0,005 / -0,020

D 11,0 - 18,0 -0,006 / -0,024

## Shank

Cylindrical h5, DIN6535 HA

## Flute

30° right hand spiral, center cutting

## Field of application

High speed cutting in steel

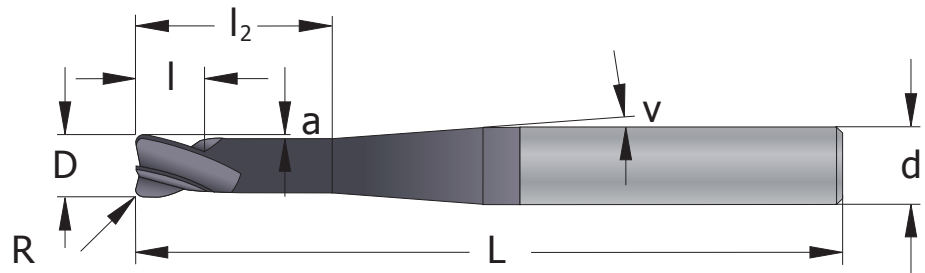

D mm	d mm	R mm	Part Number	l mm	l <sub>2</sub> mm	L mm	a mm	v °	No. of Flutes
6,0	6	0,5	MH0606D6R05L64_FC	6	25	64	0,2		4
6,0	6	0,5	MH0606D6R05L78_FC	6	35	78	0,2		4
6,0	6	1,0	MH0606D6R10L64_FC	6	25	64	0,2		4
6,0	6	1,5	MH0606D6R15L64_FC	6	25	64	0,2		4
6,0	6	1,5	MH0606D6R15L78_FC	6	35	78	0,2		4
6,0	8	0,5	MH0806D6R05L100_FC	6	25	100	0,2	2,0	4
6,0	8	1,5	MH0806D6R15L100_FC	6	25	100	0,2	2,0	4
8,0	8	0,5	MH0808D8R05L64_FC	8	25	64	0,3		4
8,0	8	0,5	MH0808D8R05L78_FC	8	25	78	0,3		4
8,0	8	1,0	MH0808D8R10L64_FC	8	25	64	0,3		4
8,0	8	1,0	MH0808D8R10L78_FC	8	35	78	0,3		4
8,0	8	1,0	MH0808D8R10L100_FC	8	50	100	0,3		4
8,0	8	2,0	MH0808D8R20L64_FC	8	25	64	0,3		4
8,0	8	2,0	MH0808D8R20L78_FC	8	35	78	0,3		4
8,0	8	2,0	MH0808D8R20L100_FC	8	50	100	0,3		4
8,0	10	1,0	MH1008D8R10L120_FC	8	30	120	0,3	1,5	4
8,0	10	2,0	MH1008D8R20L120_FC	8	30	120	0,3	1,5	4
10,0	10	0,5	MH1010D10R05L78_FC	10	35	78	0,3		4
10,0	10	1,0	MH1010D10R10L100_FC	10	55	100	0,3		4
10,0	10	2,0	MH1010D10R20L78_FC	10	35	78	0,3		4
10,0	10	2,0	MH1010D10R20L100_FC	10	55	100	0,3		4
10,0	12	2,0	MH1210D10R20L120_FC	10	30	120	0,3	1,5	4
12,0	12	0,5	MH1212D12R05L78_FC	12	35	78	0,3		4
12,0	12	1,0	MH1212D12R10L100_FC	12	55	100	0,3		4
12,0	12	2,0	MH1212D12R20L78_FC	12	35	78	0,3		4
12,0	12	2,0	MH1212D12R20L100_FC	12	55	100	0,3		4
12,0	16	2,0	MH1612D12R20L120_FC	12	40	120	0,3	4,5	4
16,0	16	3,5	MH1616D20R35L100_FC	20	50	100	0,3		4
16,0	16	3,5	MH1616D20R35L150_FC	20	100	150	0,3		4

## Two Flute, with Ball Nose

**FC**  
TiAlN coated  
Super Micrograin Carbide  
**Tolerance**  
D 1,0 - 3,0 -0,002 / -0,012  
D 4,0 - 6,0 -0,004 / -0,016  
D 7,0 - 10,0 -0,005 / -0,020  
D 11,0 - 18,0 -0,006 / -0,024  
**Shank**  
Cylindrical h5, DIN6535 HA  
**Flute**  
30° right hand spiral  
**Field of application**  
High speed cutting in steel

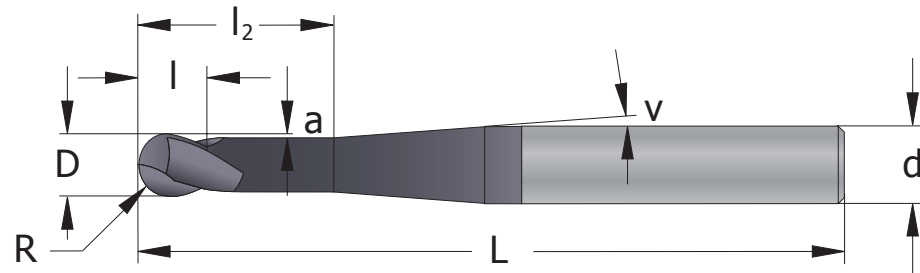

D mm	d mm	R mm	Part Number	l mm	l <sub>2</sub> mm	L mm	a mm	v °	No. of Flutes
1,0	6	0,5	RH0601B2L64_FC	2	4	64	0,05	7,0	2
1,5	6	0,75	RH06015B2L64_FC	2	4	64	0,05	6,5	2
2,0	6	1,0	RH0602B3L64_FC	3	5	64	0,05	6,0	2
2,0	6	1,0	RH0602B3L78_FC	3	15	78	0,05	5,0	2
3,0	6	1,5	RH0603B4L64_FC	4	7	64	0,05	5,0	2
3,0	6	1,5	RH0603B4L78_FC	4	15	78	0,05	4,0	2
4,0	6	2,0	RH0604B5L64_FC	5	8	64	0,1	4,0	2
4,0	6	2,0	RH0604B5L78_FC	5	15	78	0,1	2,5	2
5,0	6	2,5	RH0605B5L64_FC	5	10	64	0,15	2,5	2
5,0	6	2,5	RH0605B5L78_FC	5	20	78	0,15	2,0	2
6,0	6	3,0	RH0606B6L64_FC	6	25	64	0,2		2
6,0	6	3,0	RH0606B6L78_FC	6	35	78	0,2		2
6,0	8	3,0	RH0806B6L100_FC	6	25	100	0,2	2,0	2
6,0	8	3,0	RH0806B6L150_FC	6	15	150	0,2	1,5	2
8,0	8	4,0	RH0808B8L64_FC	8	25	64	0,3		2
8,0	8	4,0	RH0808B8L78_FC	8	35	78	0,3		2
8,0	8	4,0	RH0808B8L100_FC	8	50	100	0,3		2
8,0	10	4,0	RH1008B8L120_FC	8	30	120	0,3	1,5	2
8,0	10	4,0	RH1008B8L150_FC	8	20	150	0,3	1,5	2
10,0	10	5,0	RH1010B10L78_FC	10	35	78	0,3		2
10,0	10	5,0	RH1010B10L100_FC	10	55	100	0,3		2
10,0	12	5,0	RH1210B10L100_FC	10	30	100	0,3	3,5	2
10,0	12	5,0	RH1210B10L120_FC	10	30	120	0,3	1,5	2
10,0	12	5,0	RH1210B10L150_FC	10	25	150	0,3	1,5	2
12,0	12	6,0	RH1212B12L78_FC	12	35	78	0,3		2
12,0	12	6,0	RH1212B12L100_FC	12	55	100	0,3		2
12,0	16	6,0	RH1612B12L120_FC	12	40	120	0,3	4,5	2
12,0	16	6,0	RH1612B12L150_FC	12	30	150	0,3	2,0	2
16,0	16	8,0	RH1616B20L100_FC	20	50	100	0,3		2
16,0	16	8,0	RH1616B20L150_FC	20	100	150	0,3		2

## Four Flute, with Ball Nose

## FC

TiAlN coated

Super Micrograin Carbide

## Tolerance

D 1,0 - 3,0 -0,002 / -0,012

D 4,0 - 6,0 -0,004 / -0,016

D 7,0 - 10,0 -0,005 / -0,020

D 11,0 - 18,0 -0,006 / -0,024

## Shank

Cylindrical h5, DIN6535 HA

## Flute

30° right hand spiral

## Field of application

High speed cutting in steel

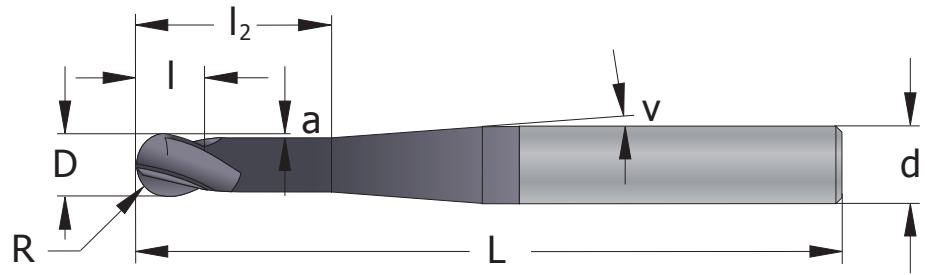

D mm	d mm	R mm	Part Number	l mm	l <sub>2</sub> mm	L mm	a mm	v °	No. of Flutes
6,0	6	3,0	RH0606D6L64_FC	6	25	64	0,2		4
6,0	6	3,0	RH0606D6L78_FC	6	35	78	0,2		4
6,0	8	3,0	RH0806D6L100_FC	6	25	100	0,2	2,0	4
8,0	8	4,0	RH0808D8L64_FC	8	25	64	0,3		4
8,0	8	4,0	RH0808D8L78_FC	8	35	78	0,3		4
8,0	8	4,0	RH0808D8L100_FC	8	50	100	0,3		4
8,0	10	4,0	RH1008D8L120_FC	8	30	120	0,3	1,5	4
10,0	10	5,0	RH1010D10L78_FC	10	35	78	0,3		4
10,0	10	5,0	RH1010D10L100_FC	10	55	100	0,3		4
10,0	12	5,0	RH1210D10L120_FC	10	30	120	0,3	1,5	4
12,0	12	6,0	RH1212D12L78_FC	12	35	78	0,3		4
12,0	12	6,0	RH1212D12L100_FC	12	55	100	0,3		4
12,0	16	6,0	RH1612D12L120_FC	12	40	120	0,3	4,5	4
16,0	16	8,0	RH1616D20L100_FC	20	50	100	0,3		4
16,0	16	8,0	RH1616D20L150_FC	20	100	150	0,3		4

## Micro, Two Flute

**DC**  
 Diamond coated  
 Micrograin Carbide  
**Tolerance**  
 D 0,3 - 3,0 -0,002 / -0,012  
**Shank**  
 Cylindrical h5, DIN6535 HA  
**Flute**  
 40° right hand spiral  
 Center cutting  
**Field of application**  
 Graphite

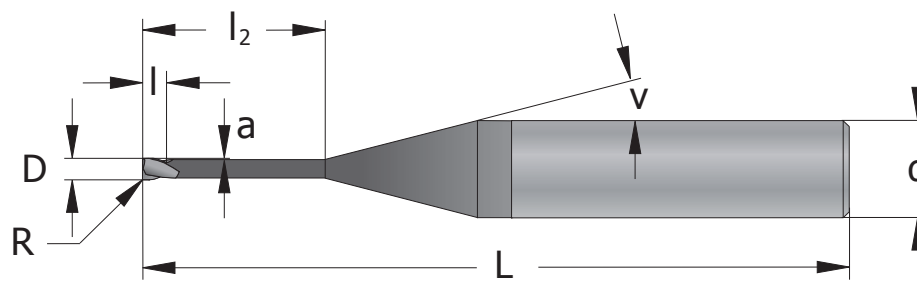

D mm	d mm	R mm	Part Number	l mm	l <sub>2</sub> mm	L mm	a mm	v °	No. of Flutes
0,3	6	0,05	MG06003B1_DC	1,0	1,0	64		7	2
0,3	6	0,05	MG06003B1.4_DC	1,5	2,5	64	0,01	7	2
0,3	6	0,05	MG06003B1.5_DC	1,5	5,0	64	0,01	8	2
0,4	6	0,05	MG06004B1_DC	1,0	1,0	64		7	2
0,4	6	0,05	MG06004B1.4_DC	1,5	2,5	64	0,01	7	2
0,4	6	0,05	MG06004B1.5_DC	1,5	5,0	64	0,01	8	2
0,5	6	0,05	MG06005B1.3_DC	1,5	1,5	64		7	2
0,5	6	0,05	MG06005B1.4_DC	1,5	3,5	64	0,01	7	2
0,5	6	0,05	MG06005B1.5_DC	1,5	7,0	64	0,01	9	2
0,5	6	0,05	MG06005B1.6_DC	1,5	10,0	64	0,01	10	2
0,6	6	0,05	MG06006B1.8_DC	1,5	1,5	64		6	2
0,6	6	0,05	MG06006B1.9_DC	2,0	3,5	64	0,025	7	2
0,6	6	0,05	MG06006B2_DC	2,0	7,0	64	0,025	9	2
0,6	6	0,05	MG06006B2.1_DC	2,0	10,0	64	0,025	10	2
0,8	6	0,05	MG06008B1.8_DC	2,0	2,0	64		6	2
0,8	6	0,05	MG06008B1.9_DC	2,0	5,0	64	0,025	8	2
0,8	6	0,05	MG06008B1.95_DC	2,0	7,5	64	0,025	9	2
0,8	6	0,05	MG06008B2_DC	2,0	10,0	64	0,025	10	2
0,8	6	0,05	MG06008B2.1_DC	2,0	15,0	64	0,025	14	2
1,0	6	0,05	MG0601B2.5_DC	2,5	2,5	64		6	2
1,0	6	0,05	MG0601B2.9_DC	3,0	5,0	64	0,025	7	2
1,0	6	0,05	MG0601B2.95_DC	3,0	7,5	64	0,025	8	2
1,0	6	0,05	MG0601B3_DC	3,0	10,0	64	0,025	10	2
1,0	6	0,05	MG0601B3.1_DC	3,0	15,0	64	0,025	13	2
1,2	6	0,05	MG06012B2.9_DC	3,0	5,0	64	0,025	7	2
1,2	6	0,05	MG06012B3_DC	3,0	10,0	64	0,025	9	2
1,5	6	0,05	MG06015B2.9_DC	3,0	5,0	64	0,025	7	2
1,5	6	0,05	MG06015B2.95_DC	3,0	7,5	64	0,025	8	2
1,5	6	0,05	MG06015B3_DC	3,0	10,0	64	0,025	9	2
1,5	6	0,05	MG06015B3.1_DC	3,0	15,0	64	0,025	12	2
1,5	6	0,05	MG06015B3.2_DC	3,0	20,0	64	0,025	15	2

### Diamond Coating: Superior Wear Resistance and Tool Life

Diamond Coated End Mills offer an unmatched level of wear resistance and durability, ideal for machining abrasive materials such as graphite. The diamond coating extends tool life by reducing friction and heat generation, ensuring consistent performance even in demanding conditions.

## Micro, Two Flute, with Ball Nose

## DC

Diamond coated  
Micrograin Carbide

## Tolerance

D 0,3 - 3,0 -0,002 / -0,012

## Shank

Cylindrical h5, DIN6535 HA

## Flute

40° right hand spiral

## Field of application

Graphite

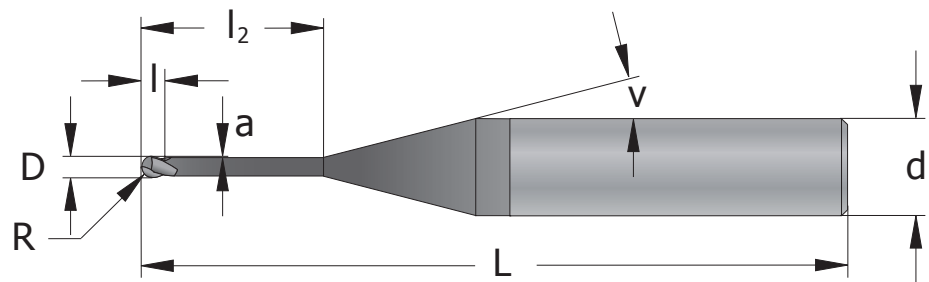

D mm	d mm	R mm	Part Number	l mm	l <sub>2</sub> mm	L mm	a mm	v °	No. of Flutes
0,3	6	0,15	RG06003B1_DC	1,0	1,0	64		7	2
0,3	6	0,15	RG06003B1.4_DC	1,5	2,5	64	0,01	7	2
0,3	6	0,15	RG06003B1.5_DC	1,5	5,0	64	0,01	8	2
0,4	6	0,2	RG06004B1_DC	1,0	1,0	64		7	2
0,4	6	0,2	RG06004B1.4_DC	1,5	2,5	64	0,01	7	2
0,4	6	0,2	RG06004B1.5_DC	1,5	5,0	64	0,01	8	2
0,5	6	0,25	RG06005B1.3_DC	1,5	1,5	64		7	2
0,5	6	0,25	RG06005B1.4_DC	1,5	3,5	64	0,01	7	2
0,5	6	0,25	RG06005B1.5_DC	1,5	7,0	64	0,01	9	2
0,5	6	0,25	RG06005B1.6_DC	1,5	10,0	64	0,01	10	2
0,6	6	0,3	RG06006B1.8_DC	1,5	1,5	64		6	2
0,6	6	0,3	RG06006B1.9_DC	2,0	3,5	64	0,025	7	2
0,6	6	0,3	RG06006B2_DC	2,0	7,0	64	0,025	9	2
0,6	6	0,3	RG06006B2.1_DC	2,0	10,0	64	0,025	10	2
0,8	6	0,4	RG06008B1.8_DC	2,0	2,0	64		6	2
0,8	6	0,4	RG06008B1.9_DC	2,0	5,0	64	0,025	8	2
0,8	6	0,4	RG06008B1.95_DC	2,0	7,5	64	0,025	9	2
0,8	6	0,4	RG06008B2_DC	2,0	10,0	64	0,025	10	2
0,8	6	0,4	RG06008B2.1_DC	2,0	15,0	64	0,025	14	2
1,0	6	0,5	RG0601B2.5_DC	2,5	2,5	64		6	2
1,0	6	0,5	RG0601B2.9_DC	3,0	5,0	64	0,025	7	2
1,0	6	0,5	RG0601B2.95_DC	3,0	7,5	64	0,025	8	2
1,0	6	0,5	RG0601B3_DC	3,0	10,0	64	0,025	10	2
1,0	6	0,5	RG0601B3.1_DC	3,0	15,0	64	0,025	13	2
1,2	6	0,6	RG06012B2.9_DC	3,0	5,0	64	0,025	7	2
1,2	6	0,6	RG06012B3_DC	3,0	10,0	64	0,025	9	2
1,5	6	0,75	RG06015B2.9_DC	3,0	5,0	64	0,025	7	2
1,5	6	0,75	RG06015B2.95_DC	3,0	7,5	64	0,025	8	2
1,5	6	0,75	RG06015B3_DC	3,0	10,0	64	0,025	9	2
1,5	6	0,75	RG06015B3.1_DC	3,0	15,0	64	0,025	12	2
1,5	6	0,75	RG06015B3.2_DC	3,0	20,0	64	0,025	15	2



## Three Flute, with Corner Radius

**DC**  
 Diamond coated  
 Micrograin Carbide  
**Tolerance**  
 D 1,0 - 3,0 -0,002 / -0,012  
 D 4,0 - 6,0 -0,004 / -0,016  
 D 7,0 - 10,0 -0,005 / -0,020  
 D 11,0 - 18,0 -0,006 / -0,024  
**Shank**  
 Cylindrical h5, DIN6535 HA  
**Flute**  
 40° right hand spiral, center cutting  
**Field of application**  
 Graphite

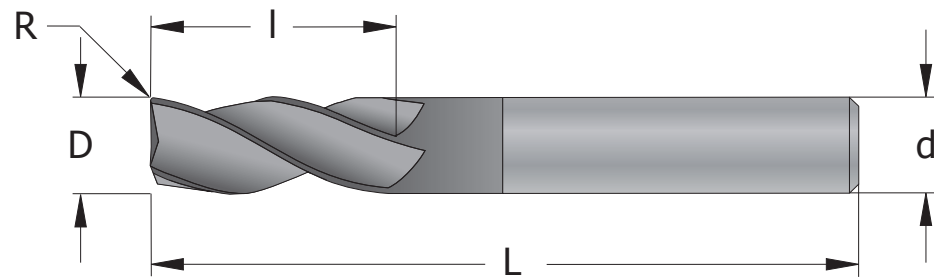

D mm	d mm	R mm	Part Number	l mm	L mm	No. of Flutes
2,0	3	0,1	MG0302C10_DC	10	50	3
3,0	3	0,1	MG0303C10_DC	10	50	3
4,0	4	0,2	MG0404C15_DC	15	60	3
5,0	5	0,2	MG0505C20_DC	20	60	3
6,0	6	0,3	MG0606C30_DC	30	78	3
8,0	8	0,3	MG0808C30_DC	30	78	3
10,0	10	0,3	MG1010C30_DC	30	78	3
12,0	12	0,3	MG1212C30_DC	30	89	3

## Two Flute, with Corner Radius, Long Shank

**DC**  
 Diamond coated  
 Micrograin Carbide  
**Tolerance**  
 D 1,0 - 3,0 -0,002 / -0,012  
 D 4,0 - 6,0 -0,004 / -0,016  
 D 7,0 - 10,0 -0,005 / -0,020  
 D 11,0 - 18,0 -0,006 / -0,024  
**Shank**  
 Cylindrical h5, DIN6535 HA  
**Flute**  
 40° right hand spiral, center cutting  
**Field of application**  
 Graphite

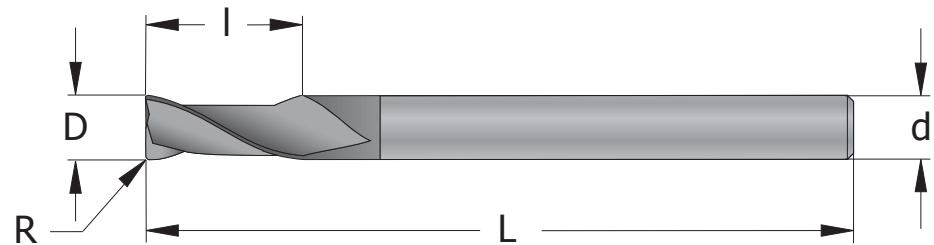

D mm	d mm	R mm	Part Number	l mm	L mm	No. of Flutes
4,0	4	0,3	MG0404B10L100_DC	10	100	2
5,0	5	0,5	MG0505B13L100_DC	13	100	2
6,0	6	0,5	MG0606B42L100_DC	42	100	2
6,0	6	0,5	MG0606B26L150_DC	26	150	2
8,0	8	0,5	MG0808B41L150_DC	41	150	2
10,0	10	0,5	MG1010B42L150_DC	42	150	2

**DC**

Diamond coated  
Micrograin Carbide

**Tolerance**

D 1,0 - 3,0 -0,002 / -0,012

D 4,0 - 6,0 -0,004 / -0,016

D 7,0 - 10,0 -0,005 / -0,020

D 11,0 - 18,0 -0,006 / -0,024

**Shank**

Cylindrical h5, DIN6535 HA

**Flute**

40° right hand spiral, center cutting

**Field of application**

Graphite

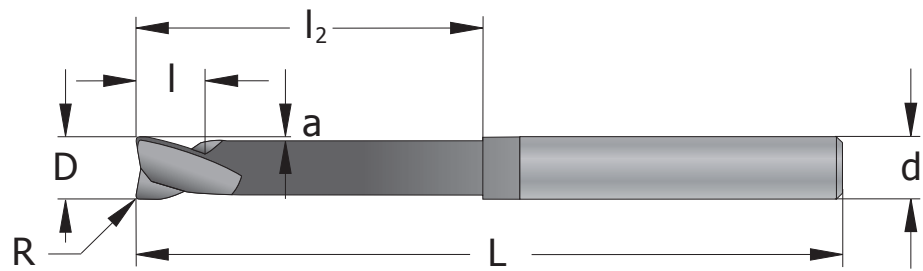

D mm	d mm	R mm	Part Number	l mm	l <sub>2</sub> mm	L mm	a mm	No. of Flutes
2,0	3	0,1	MG0302B3_DC	3	10	50	0,1	2
3,0	6	0,1	MG0603B4_DC	4	10	50	0,1	2
4,0	6	0,2	MG0604D4_DC	4	10	50	0,1	4
5,0	6	0,2	MG0605D5_DC	5	10	50	0,15	4
6,0	6	0,3	MG0606D6_DC	6	10	50	0,2	4
8,0	8	0,3	MG0808D8_DC	8	15	64	0,3	4
10,0	10	0,3	MG1010D10_DC	10	20	78	0,3	4
12,0	12	0,3	MG1212D10_DC	10	20	78	0,3	4

## Three Flute, with Ball Nose

**DC**  
 Diamond coated  
 Micrograin Carbide  
**Tolerance**  
 D 1,0 - 3,0 -0,002 / -0,012  
 D 4,0 - 6,0 -0,004 / -0,016  
 D 7,0 - 10,0 -0,005 / -0,020  
 D 11,0 - 18,0 -0,006 / -0,024  
**Shank**  
 Cylindrical h5, DIN6535 HA  
**Flute**  
 40° right hand spiral  
**Field of application**  
 Graphite

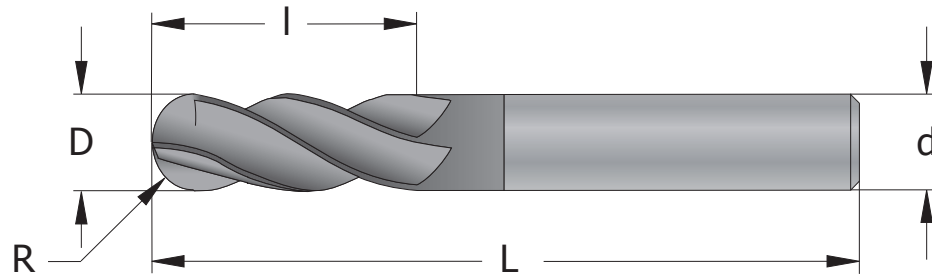

D mm	d mm	R mm	Part Number	l mm	L mm	No. of Flutes
2,0	3	1,0	RG0302C10_DC	10	50	3
3,0	3	1,5	RG0303C10_DC	10	50	3
4,0	4	2,0	RG0404C15_DC	15	60	3
5,0	5	2,5	RG0505C20_DC	20	60	3
6,0	6	3,0	RG0606C30_DC	30	78	3
8,0	8	4,0	RG0808C30_DC	30	78	3
10,0	10	5,0	RG1010C30_DC	30	78	3
12,0	12	6,0	RG1212C30_DC	30	89	3

## Two Flute, with Ball Nose, Long Shank

**DC**  
 Diamond coated  
 Micrograin Carbide  
**Tolerance**  
 D 1,0 - 3,0 -0,002 / -0,012  
 D 4,0 - 6,0 -0,004 / -0,016  
 D 7,0 - 10,0 -0,005 / -0,020  
 D 11,0 - 18,0 -0,006 / -0,024  
**Shank**  
 Cylindrical h5, DIN6535 HA  
**Flute**  
 40° right hand spiral  
**Field of application**  
 Graphite

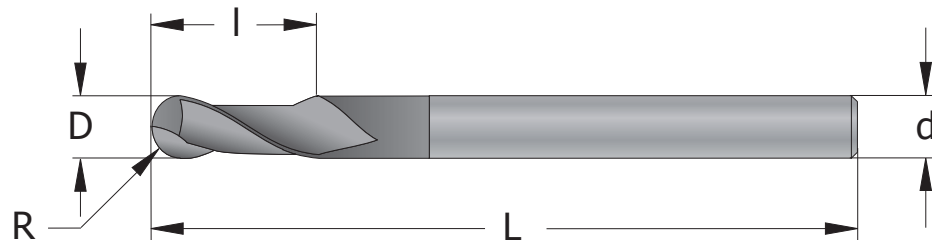

D mm	d mm	R mm	Part Number	l mm	L mm	No. of Flutes
2,0	3	1,0	RG0302B6L100_DC	6	100	2
3,0	3	1,5	RG0303B16L100_DC	16	100	2
4,0	4	2,0	RG0404B16L100_DC	16	100	2
6,0	6	3,0	RG0606B42L100_DC	42	100	2
6,0	6	3,0	RG0606B42L150_DC	42	150	2
8,0	8	4,0	RG0808B42L100_DC	42	100	2
8,0	8	4,0	RG0808B42L150_DC	42	150	2
10,0	10	5,0	RG1010B45L150_DC	45	150	2

## Two/Four Flute, with Ball Nose

**DC**

Diamond coated  
Micrograin Carbide

**Tolerance**

D 1,0 - 3,0 -0,002 / -0,012

D 4,0 - 6,0 -0,004 / -0,016

D 7,0 - 10,0 -0,005 / -0,020

D 11,0 - 18,0 -0,006 / -0,024

**Shank**

Cylindrical h5, DIN6535 HA

**Flute**

40° right hand spiral

**Field of application**

Graphite

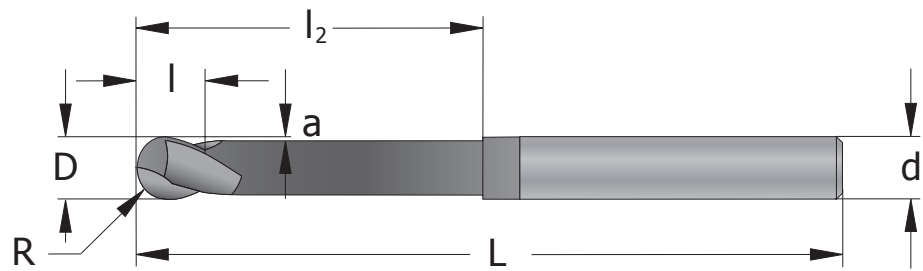

D mm	d mm	R mm	Part Number	l mm	l <sub>2</sub> mm	L mm	a mm	No. of Flutes
2,0	3	1,0	RG0302B3_DC	3	10	50	0,1	2
3,0	6	1,5	RG0603B4_DC	4	10	50	0,1	2
4,0	6	2,0	RG0604D4_DC	4	10	50	0,1	4
5,0	6	2,5	RG0605D5_DC	5	10	50	0,15	4
6,0	6	3,0	RG0606D6_DC	6	10	50	0,2	4
8,0	8	4,0	RG0808D8_DC	8	15	64	0,3	4
10,0	10	5,0	RG1010D10_DC	10	20	78	0,3	4
12,0	12	6,0	RG1212D10_DC	10	20	78	0,3	4

## Solid Carbide Drills

Experience exceptional performance with our high-quality Solid Carbide Drills. Crafted from Super Micrograin Carbide and featuring a TiAlN coating, these drills offer outstanding heat resistance and extended tool life. With a wide range of dimensions readily available in stock, SmiCut provides the perfect solution for your drilling needs.



- 3xD, Ø3 – 20 mm
- 5xD, Ø3 – 20 mm
- 3xD with internal coolant, Ø3 – 20 mm
- 5xD with internal coolant, Ø3 – 20 mm
- 8xD with internal coolant, Ø3 – 16 mm



# SOLID CARBIDE DRILLS

## CONTENTS

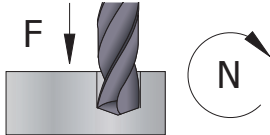

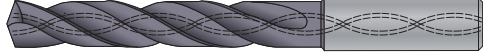
Technical Information	112	
Solid Carbide Drills	114	
Solid Carbide Drills with Internal Coolant	118	

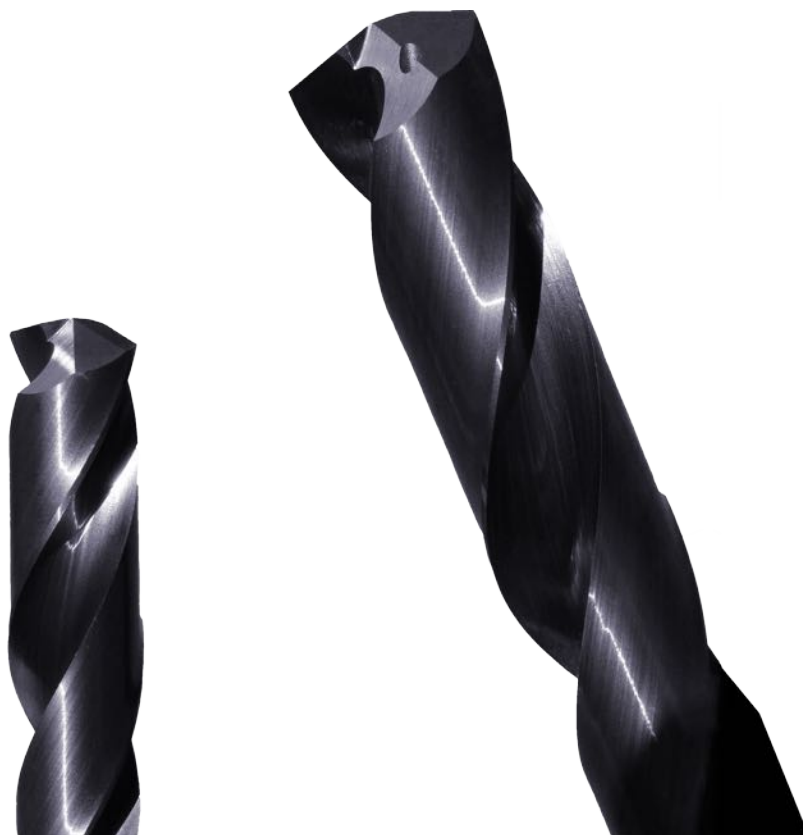

## Cutting Speed ( $V_c$ ) and Material Factor ( $F_m$ )

MATERIAL		Hardness HB	Tensile Strength N/mm <sup>2</sup>	Cutting Speed ( $V_c$ ) m/min	Material Factor ( $F_m$ )
Steel	Low carbon, C < 0,25%	< 120	< 400	80 - 120	1,2
	Medium carbon, C < 0,55%	< 200	< 700	70 - 110	1,1
	High carbon, C < 0,85%	< 250	< 850	60 - 100	1,0
	Low alloy	< 250	< 850	60 - 100	1,0
	High alloy	< 350	< 1200	40 - 60	0,9
	Hardened, HRC < 45			30 - 50	0,8
	Hardened, HRC < 55			20 - 30	0,7
	Hardened, HRC < 65			15 - 25	0,6
Cast iron	Lamellar graphite	< 150	< 500	70 - 110	1,2
	Lamellar graphite	< 300	< 1000	60 - 100	1,1
	Nodular graphite, malleable	< 200	< 700	50 - 80	1,0
	Nodular graphite, malleable	< 300	< 1000	40 - 70	0,9
Stainless steel	Free machining	< 250	< 850	40 - 55	1,0
	Austenitic	< 250	< 850	30 - 45	0,9
	Ferritic and austenitic	< 300	< 1000	25 - 40	0,8
Titanium	Unalloyed	< 200	< 700	35 - 50	0,8
	Alloyed	< 270	< 900	25 - 40	0,7
	Alloyed	< 350	< 1250	20 - 35	0,6
Nickel	Unalloyed	< 150	< 500	40 - 55	0,8
	Alloyed	< 270	< 900	25 - 35	0,7
	Alloyed	< 350	< 1250	20 - 30	0,6
Copper	Unalloyed	< 100	< 350	80 - 160	1,0
	Brass, bronze	< 200	< 700	70 - 150	1,0
	High strength bronze	< 470	< 1500	50 - 70	0,8
Aluminium	Unalloyed	< 100	< 350	200 - 300	1,4
	Alloyed, Si < 0.5%	< 150	< 500	150 - 250	1,3
	Alloyed, Si < 10%	< 120	< 400	100 - 200	1,2
	Alloyed, Si > 10%	< 120	< 400	80 - 160	1,1
Inconel	718	< 370		20 - 30	0,6
Graphite				100 - 200	1,0

■ 20% higher cutting speed is recommended for drill with internal coolant.

## Code Key

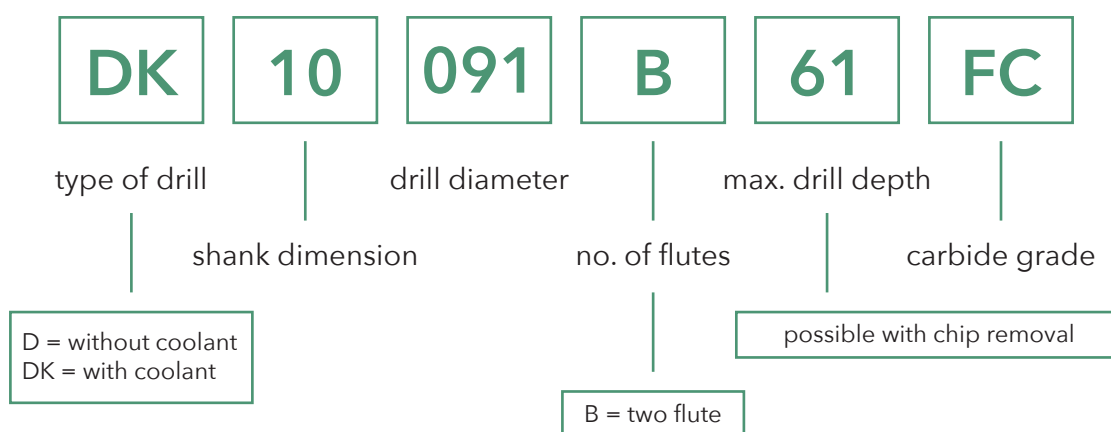

## Diameter Factor ( $F_d$ )

D	Diameter Factor ( $F_d$ )		
	3xD	5xD	8xD
3,0	0,12	0,10	0,08
4,0	0,14	0,11	0,10
5,0	0,17	0,14	0,12
6,0	0,20	0,16	0,14
8,0	0,26	0,21	0,18
10,0	0,34	0,27	0,24
12,0	0,38	0,30	0,27
14,0	0,41	0,33	0,29
16,0	0,44	0,35	0,31
18,0	0,46	0,37	0,32
20,0	0,50	0,40	0,35

## Example

Drilling with D10100B47 FC (3xD)

Carbon Steel, up to 700 N/mm<sup>2</sup>

D = 10,0 mm

$F_n = 1,1 \times 0,34 = 0,37$  mm/r

$n = (90 \times 1000) / (\pi \times 10) = 2865$  rpm

$V_f = 0,37 \times 2865 = 1060$  mm/min

$$F_n = F_m \times F_d$$

$$n = \frac{V_c \times 1000}{\pi \times D}$$

D = drill diameter (mm)

$F_n$  = feed / rev. (mm/r)

n = spindle speed (rpm)

$V_c$  = cutting speed (m/min)

$V_f$  = table feed (mm/min)

$$V_f = F_n \times n$$

## Carbide Grades

FC

Super Micrograin Carbide with TiAlN coating.  
All-round grade with high heat resistance.  
Use cutting data according to the tables.



## 3xD, 5xD

DIN 6537  
**FC**  
 TiAlN coated  
 Super Micrograin Carbide  
**Tolerance**  
 D m7  
**Shank**  
 Cylindrical h6, DIN 6535 HA  
**Flute**  
 30° right hand spiral  
 140° point angle  
**Field of application**  
 All types of steel

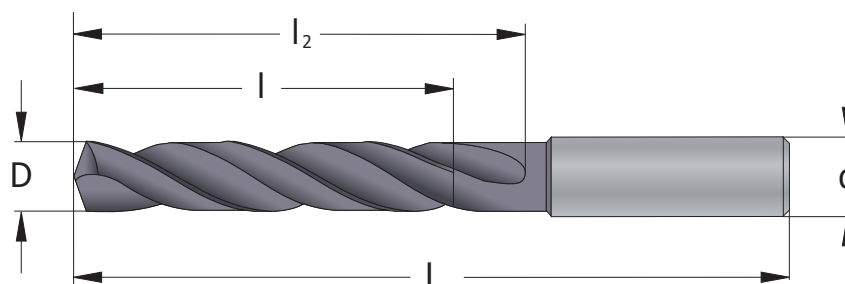

D mm	d mm	Part Number	Type	l mm	l <sub>2</sub> mm	L mm
3,0	6	D06030B20_FC	3xD	14	20	62
3,0	6	D06030B28_FC	5xD	23	28	66
3,1	6	D06031B20_FC	3xD	14	20	62
3,1	6	D06031B28_FC	5xD	23	28	66
3,2	6	D06032B20_FC	3xD	14	20	62
3,2	6	D06032B28_FC	5xD	23	28	66
3,3	6	D06033B20_FC	3xD	14	20	62
3,3	6	D06033B28_FC	5xD	23	28	66
3,4	6	D06034B20_FC	3xD	14	20	62
3,4	6	D06034B28_FC	5xD	23	28	66
3,5	6	D06035B20_FC	3xD	14	20	62
3,5	6	D06035B28_FC	5xD	23	28	66
3,6	6	D06036B20_FC	3xD	14	20	62
3,6	6	D06036B28_FC	5xD	23	28	66
3,7	6	D06037B20_FC	3xD	14	20	62
3,7	6	D06037B28_FC	5xD	23	28	66
3,8	6	D06038B24_FC	3xD	17	24	66
3,8	6	D06038B36_FC	5xD	29	36	74
3,9	6	D06039B24_FC	3xD	17	24	66
3,9	6	D06039B36_FC	5xD	29	36	74
4,0	6	D06040B24_FC	3xD	17	24	66
4,0	6	D06040B36_FC	5xD	29	36	74
4,1	6	D06041B24_FC	3xD	17	24	66
4,1	6	D06041B36_FC	5xD	29	36	74
4,2	6	D06042B24_FC	3xD	17	24	66
4,2	6	D06042B36_FC	5xD	29	36	74
4,3	6	D06043B24_FC	3xD	17	24	66
4,3	6	D06043B36_FC	5xD	29	36	74
4,4	6	D06044B24_FC	3xD	17	24	66
4,4	6	D06044B36_FC	5xD	29	36	74
4,5	6	D06045B24_FC	3xD	17	24	66
4,5	6	D06045B36_FC	5xD	29	36	74
4,6	6	D06046B24_FC	3xD	17	24	66
4,6	6	D06046B36_FC	5xD	29	36	74
4,7	6	D06047B24_FC	3xD	17	24	66
4,7	6	D06047B36_FC	5xD	29	36	74
4,8	6	D06048B28_FC	3xD	20	28	66
4,8	6	D06048B44_FC	5xD	35	44	82
4,9	6	D06049B28_FC	3xD	20	28	66
4,9	6	D06049B44_FC	5xD	35	44	82
5,0	6	D06050B28_FC	3xD	20	28	66
5,0	6	D06050B44_FC	5xD	35	44	82
5,1	6	D06051B28_FC	3xD	20	28	66
5,1	6	D06051B44_FC	5xD	35	44	82
5,2	6	D06052B28_FC	3xD	20	28	66
5,2	6	D06052B44_FC	5xD	35	44	82
5,3	6	D06053B28_FC	3xD	20	28	66

D mm	d mm	Part Number	Type	l mm	l <sub>2</sub> mm	L mm
5,3	6	D06053B44_FC	5xD	35	44	82
5,4	6	D06054B28_FC	3xD	20	28	66
5,4	6	D06054B44_FC	5xD	35	44	82
5,5	6	D06055B28_FC	3xD	20	28	66
5,5	6	D06055B44_FC	5xD	35	44	82
5,6	6	D06056B28_FC	3xD	20	28	66
5,6	6	D06056B44_FC	5xD	35	44	82
5,7	6	D06057B28_FC	3xD	20	28	66
5,7	6	D06057B44_FC	5xD	35	44	82
5,8	6	D06058B28_FC	3xD	20	28	66
5,8	6	D06058B44_FC	5xD	35	44	82
5,9	6	D06059B28_FC	3xD	20	28	66
5,9	6	D06059B44_FC	5xD	35	44	82
6,0	6	D06060B28_FC	3xD	20	28	66
6,0	6	D06060B44_FC	5xD	35	44	82
6,1	8	D08061B34_FC	3xD	24	34	79
6,1	8	D08061B53_FC	5xD	43	53	91
6,2	8	D08062B34_FC	3xD	24	34	79
6,2	8	D08062B53_FC	5xD	43	53	91
6,3	8	D08063B34_FC	3xD	24	34	79
6,3	8	D08063B53_FC	5xD	43	53	91
6,4	8	D08064B34_FC	3xD	24	34	79
6,4	8	D08064B53_FC	5xD	43	53	91
6,5	8	D08065B34_FC	3xD	24	34	79
6,5	8	D08065B53_FC	5xD	43	53	91
6,6	8	D08066B34_FC	3xD	24	34	79
6,6	8	D08066B53_FC	5xD	43	53	91
6,7	8	D08067B34_FC	3xD	24	34	79
6,7	8	D08067B53_FC	5xD	43	53	91
6,8	8	D08068B34_FC	3xD	24	34	79
6,8	8	D08068B53_FC	5xD	43	53	91
6,9	8	D08069B34_FC	3xD	24	34	79
6,9	8	D08069B53_FC	5xD	43	53	91
7,0	8	D08070B34_FC	3xD	24	34	79
7,0	8	D08070B53_FC	5xD	43	53	91
7,1	8	D08071B41_FC	3xD	29	41	79
7,1	8	D08071B53_FC	5xD	43	53	91
7,2	8	D08072B41_FC	3xD	29	41	79
7,2	8	D08072B53_FC	5xD	43	53	91
7,3	8	D08073B41_FC	3xD	29	41	79
7,3	8	D08073B53_FC	5xD	43	53	91
7,4	8	D08074B41_FC	3xD	29	41	79
7,4	8	D08074B53_FC	5xD	43	53	91
7,5	8	D08075B41_FC	3xD	29	41	79
7,5	8	D08075B53_FC	5xD	43	53	91
7,6	8	D08076B41_FC	3xD	29	41	79
7,6	8	D08076B53_FC	5xD	43	53	91
7,7	8	D08077B41_FC	3xD	29	41	79
7,7	8	D08077B53_FC	5xD	43	53	91
7,8	8	D08078B41_FC	3xD	29	41	79
7,8	8	D08078B53_FC	5xD	43	53	91
7,9	8	D08079B41_FC	3xD	29	41	79
7,9	8	D08079B53_FC	5xD	43	53	91
8,0	8	D08080B41_FC	3xD	29	41	79
8,0	8	D08080B53_FC	5xD	43	53	91
8,1	10	D10081B47_FC	3xD	35	47	89
8,1	10	D10081B61_FC	5xD	49	61	103
8,2	10	D10082B47_FC	3xD	35	47	89
8,2	10	D10082B61_FC	5xD	49	61	103
8,3	10	D10083B47_FC	3xD	35	47	89
8,3	10	D10083B61_FC	5xD	49	61	103

## 3xD, 5xD

D mm	d mm	Part Number	Type	l mm	l <sub>2</sub> mm	L mm
8,4	10	D10084B47_FC	3xD	35	47	89
8,4	10	D10084B61_FC	5xD	49	61	103
8,5	10	D10085B47_FC	3xD	35	47	89
8,5	10	D10085B61_FC	5xD	49	61	103
8,6	10	D10086B47_FC	3xD	35	47	89
8,6	10	D10086B61_FC	5xD	49	61	103
8,7	10	D10087B47_FC	3xD	35	47	89
8,7	10	D10087B61_FC	5xD	49	61	103
8,8	10	D10088B47_FC	3xD	35	47	89
8,8	10	D10088B61_FC	5xD	49	61	103
8,9	10	D10089B47_FC	3xD	35	47	89
8,9	10	D10089B61_FC	5xD	49	61	103
9,0	10	D10090B47_FC	3xD	35	47	89
9,0	10	D10090B61_FC	5xD	49	61	103
9,1	10	D10091B47_FC	3xD	35	47	89
9,1	10	D10091B61_FC	5xD	49	61	103
9,2	10	D10092B47_FC	3xD	35	47	89
9,2	10	D10092B61_FC	5xD	49	61	103
9,3	10	D10093B47_FC	3xD	35	47	89
9,3	10	D10093B61_FC	5xD	49	61	103
9,4	10	D10094B47_FC	3xD	35	47	89
9,4	10	D10094B61_FC	5xD	49	61	103
9,5	10	D10095B47_FC	3xD	35	47	89
9,5	10	D10095B61_FC	5xD	49	61	103
9,6	10	D10096B47_FC	3xD	35	47	89
9,6	10	D10096B61_FC	5xD	49	61	103
9,7	10	D10097B47_FC	3xD	35	47	89
9,7	10	D10097B61_FC	5xD	49	61	103
9,8	10	D10098B47_FC	3xD	35	47	89
9,8	10	D10098B61_FC	5xD	49	61	103
9,9	10	D10099B47_FC	3xD	35	47	89
9,9	10	D10099B61_FC	5xD	49	61	103
10,0	10	D10100B47_FC	3xD	35	47	89
10,0	10	D10100B61_FC	5xD	49	61	103
10,1	12	D12101B55_FC	3xD	40	55	102
10,1	12	D12101B71_FC	5xD	56	71	118
10,2	12	D12102B55_FC	3xD	40	55	102
10,2	12	D12102B71_FC	5xD	56	71	118
10,3	12	D12103B55_FC	3xD	40	55	102
10,3	12	D12103B71_FC	5xD	56	71	118
10,4	12	D12104B55_FC	3xD	40	55	102
10,4	12	D12104B71_FC	5xD	56	71	118
10,5	12	D12105B55_FC	3xD	40	55	102
10,5	12	D12105B71_FC	5xD	56	71	118
10,6	12	D12106B55_FC	3xD	40	55	102
10,6	12	D12106B71_FC	5xD	56	71	118
10,7	12	D12107B55_FC	3xD	40	55	102
10,7	12	D12107B71_FC	5xD	56	71	118
10,8	12	D12108B55_FC	3xD	40	55	102
10,8	12	D12108B71_FC	5xD	56	71	118
10,9	12	D12109B55_FC	3xD	40	55	102
10,9	12	D12109B71_FC	5xD	56	71	118
11,0	12	D12110B55_FC	3xD	40	55	102
11,0	12	D12110B71_FC	5xD	56	71	118
11,1	12	D12111B55_FC	3xD	40	55	102
11,1	12	D12111B71_FC	5xD	56	71	118
11,2	12	D12112B55_FC	3xD	40	55	102
11,2	12	D12112B71_FC	5xD	56	71	118
11,3	12	D12113B55_FC	3xD	40	55	102
11,3	12	D12113B71_FC	5xD	56	71	118
11,4	12	D12114B55_FC	3xD	40	55	102

D mm	d mm	Part Number	Type	l mm	l <sub>2</sub> mm	L mm
11,4	12	D12114B71_FC	5xD	56	71	118
11,5	12	D12115B55_FC	3xD	40	55	102
11,5	12	D12115B71_FC	5xD	56	71	118
11,6	12	D12116B55_FC	3xD	40	55	102
11,6	12	D12116B71_FC	5xD	56	71	118
11,7	12	D12117B55_FC	3xD	40	55	102
11,7	12	D12117B71_FC	5xD	56	71	118
11,8	12	D12118B55_FC	3xD	40	55	102
11,8	12	D12118B71_FC	5xD	56	71	118
11,9	12	D12119B55_FC	3xD	40	55	102
11,9	12	D12119B71_FC	5xD	56	71	118
12,0	12	D12120B55_FC	3xD	40	55	102
12,0	12	D12120B71_FC	5xD	56	71	118
12,5	14	D14125B60_FC	3xD	43	60	107
12,5	14	D14125B77_FC	5xD	60	77	124
13,0	14	D14130B60_FC	3xD	43	60	107
13,0	14	D14130B77_FC	5xD	60	77	124
13,5	14	D14135B60_FC	3xD	43	60	107
13,5	14	D14135B77_FC	5xD	60	77	124
14,0	14	D14140B60_FC	3xD	43	60	107
14,0	14	D14140B77_FC	5xD	60	77	124
14,5	16	D16145B65_FC	3xD	45	65	115
14,5	16	D16145B83_FC	5xD	63	83	133
15,0	16	D16150B65_FC	3xD	45	65	115
15,0	16	D16150B83_FC	5xD	63	83	133
15,5	16	D16155B65_FC	3xD	45	65	115
15,5	16	D16155B83_FC	5xD	63	83	133
16,0	16	D16160B65_FC	3xD	45	65	115
16,0	16	D16160B83_FC	5xD	63	83	133
16,5	18	D18165B73_FC	3xD	51	73	123
16,5	18	D18165B93_FC	5xD	71	93	143
17,0	18	D18170B73_FC	3xD	51	73	123
17,0	18	D18170B93_FC	5xD	71	93	143
17,5	18	D18175B73_FC	3xD	51	73	123
17,5	18	D18175B93_FC	5xD	71	93	143
18,0	18	D18180B73_FC	3xD	51	73	123
18,0	18	D18180B93_FC	5xD	71	93	143
18,5	20	D20185B79_FC	3xD	55	79	131
18,5	20	D20185B101_FC	5xD	77	101	153
19,0	20	D20190B79_FC	3xD	55	79	131
19,0	20	D20190B101_FC	5xD	77	101	153
19,5	20	D20195B79_FC	3xD	55	79	131
19,5	20	D20195B101_FC	5xD	77	101	153
20,0	20	D20200B79_FC	3xD	55	79	131
20,0	20	D20200B101_FC	5xD	77	101	153

## with Internal Coolant, 3xD, 5xD, 8xD

DIN 6537  
**FC**  
 TiAlN coated  
 Super Micrograin Carbide  
**Tolerance**  
 D m7  
**Shank**  
 Cylindrical h6, DIN 6535 HA  
**Flute**  
 30° right hand spiral  
 140° point angle  
**Field of application**  
 All types of steel

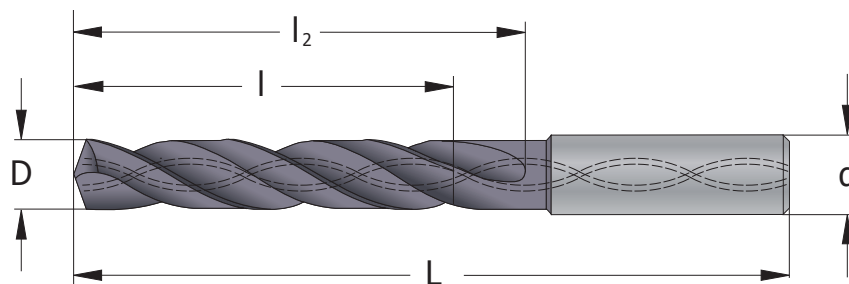

D mm	d mm	Part Number	Type	l mm	l <sub>2</sub> mm	L mm
3,0	6	DK06030B20_FC	3xD	14	20	62
3,0	6	DK06030B28_FC	5xD	23	28	66
3,0	6	DK06030B50_FC	8xD	38	50	95
3,1	6	DK06031B20_FC	3xD	14	20	62
3,1	6	DK06031B28_FC	5xD	23	28	66
3,2	6	DK06032B20_FC	3xD	14	20	62
3,2	6	DK06032B28_FC	5xD	23	28	66
3,3	6	DK06033B20_FC	3xD	14	20	62
3,3	6	DK06033B28_FC	5xD	23	28	66
3,4	6	DK06034B20_FC	3xD	14	20	62
3,4	6	DK06034B28_FC	5xD	23	28	66
3,5	6	DK06035B20_FC	3xD	14	20	62
3,5	6	DK06035B28_FC	5xD	23	28	66
3,5	6	DK06035B50_FC	8xD	38	50	95
3,6	6	DK06036B20_FC	3xD	14	20	62
3,6	6	DK06036B28_FC	5xD	23	28	66
3,7	6	DK06037B20_FC	3xD	14	20	62
3,7	6	DK06037B28_FC	5xD	23	28	66
3,8	6	DK06038B24_FC	3xD	17	24	66
3,8	6	DK06038B36_FC	5xD	29	36	74
3,9	6	DK06039B24_FC	3xD	17	24	66
3,9	6	DK06039B36_FC	5xD	29	36	74
4,0	6	DK06040B24_FC	3xD	17	24	66
4,0	6	DK06040B36_FC	5xD	29	36	74
4,0	6	DK06040B50_FC	8xD	38	50	95
4,1	6	DK06041B24_FC	3xD	17	24	66
4,1	6	DK06041B36_FC	5xD	29	36	74
4,2	6	DK06042B24_FC	3xD	17	24	66
4,2	6	DK06042B36_FC	5xD	29	36	74
4,3	6	DK06043B24_FC	3xD	17	24	66
4,3	6	DK06043B36_FC	5xD	29	36	74
4,4	6	DK06044B24_FC	3xD	17	24	66
4,4	6	DK06044B36_FC	5xD	29	36	74
4,5	6	DK06045B24_FC	3xD	17	24	66
4,5	6	DK06045B36_FC	5xD	29	36	74
4,5	6	DK06045B50_FC	8xD	38	50	95
4,6	6	DK06046B24_FC	3xD	17	24	66
4,6	6	DK06046B36_FC	5xD	29	36	74
4,7	6	DK06047B24_FC	3xD	17	24	66
4,7	6	DK06047B36_FC	5xD	29	36	74
4,8	6	DK06048B28_FC	3xD	20	28	66
4,8	6	DK06048B44_FC	5xD	35	44	82
4,9	6	DK06049B28_FC	3xD	20	28	66
4,9	6	DK06049B44_FC	5xD	35	44	82
5,0	6	DK06050B28_FC	3xD	20	28	66
5,0	6	DK06050B44_FC	5xD	35	44	82
5,0	6	DK06050B50_FC	8xD	38	50	95

D mm	d mm	Part Number	Type	l mm	l <sub>2</sub> mm	L mm
5,1	6	DK06051B28_FC	3xD	20	28	66
5,1	6	DK06051B44_FC	5xD	35	44	82
5,2	6	DK06052B28_FC	3xD	20	28	66
5,2	6	DK06052B44_FC	5xD	35	44	82
5,3	6	DK06053B28_FC	3xD	20	28	66
5,3	6	DK06053B44_FC	5xD	35	44	82
5,4	6	DK06054B28_FC	3xD	20	28	66
5,4	6	DK06054B44_FC	5xD	35	44	82
5,5	6	DK06055B28_FC	3xD	20	28	66
5,5	6	DK06055B44_FC	5xD	35	44	82
5,5	6	DK06055B50_FC	8xD	38	50	95
5,6	6	DK06056B28_FC	3xD	20	28	66
5,6	6	DK06056B44_FC	5xD	35	44	82
5,7	6	DK06057B28_FC	3xD	20	28	66
5,7	6	DK06057B44_FC	5xD	35	44	82
5,8	6	DK06058B28_FC	3xD	20	28	66
5,8	6	DK06058B44_FC	5xD	35	44	82
5,9	6	DK06059B28_FC	3xD	20	28	66
5,9	6	DK06059B44_FC	5xD	35	44	82
6,0	6	DK06060B28_FC	3xD	20	28	66
6,0	6	DK06060B44_FC	5xD	35	44	82
6,0	6	DK06060B50_FC	8xD	38	50	95
6,1	8	DK08061B34_FC	3xD	24	34	79
6,1	8	DK08061B53_FC	5xD	43	53	91
6,2	8	DK08062B34_FC	3xD	24	34	79
6,2	8	DK08062B53_FC	5xD	43	53	91
6,3	8	DK08063B34_FC	3xD	24	34	79
6,3	8	DK08063B53_FC	5xD	43	53	91
6,4	8	DK08064B34_FC	3xD	24	34	79
6,4	8	DK08064B53_FC	5xD	43	53	91
6,5	8	DK08065B34_FC	3xD	24	34	79
6,5	8	DK08065B53_FC	5xD	43	53	91
6,5	8	DK08065B66_FC	8xD	50	66	114
6,6	8	DK08066B34_FC	3xD	24	34	79
6,6	8	DK08066B53_FC	5xD	43	53	91
6,7	8	DK08067B34_FC	3xD	24	34	79
6,7	8	DK08067B53_FC	5xD	43	53	91
6,8	8	DK08068B34_FC	3xD	24	34	79
6,8	8	DK08068B53_FC	5xD	43	53	91
6,9	8	DK08069B34_FC	3xD	24	34	79
6,9	8	DK08069B53_FC	5xD	43	53	91
7,0	8	DK08070B34_FC	3xD	24	34	79
7,0	8	DK08070B53_FC	5xD	43	53	91
7,0	8	DK08070B76_FC	8xD	60	76	114
7,1	8	DK08071B41_FC	3xD	29	41	79
7,1	8	DK08071B53_FC	5xD	43	53	91
7,2	8	DK08072B41_FC	3xD	29	41	79
7,2	8	DK08072B53_FC	5xD	43	53	91
7,3	8	DK08073B41_FC	3xD	29	41	79
7,3	8	DK08073B53_FC	5xD	43	53	91
7,4	8	DK08074B41_FC	3xD	29	41	79
7,4	8	DK08074B53_FC	5xD	43	53	91
7,5	8	DK08075B41_FC	3xD	29	41	79
7,5	8	DK08075B53_FC	5xD	43	53	91
7,5	8	DK08075B76_FC	8xD	60	76	114
7,6	8	DK08076B41_FC	3xD	29	41	79
7,6	8	DK08076B53_FC	5xD	43	53	91
7,7	8	DK08077B41_FC	3xD	29	41	79
7,7	8	DK08077B53_FC	5xD	43	53	91
7,8	8	DK08078B41_FC	3xD	29	41	79
7,8	8	DK08078B53_FC	5xD	43	53	91

## with Internal Coolant, 3xD, 5xD, 8xD

D mm	d mm	Part Number	Type	l mm	l <sub>2</sub> mm	L mm
7,9	8	DK08079B41_FC	3xD	29	41	79
7,9	8	DK08079B53_FC	5xD	43	53	91
8,0	8	DK08080B41_FC	3xD	29	41	79
8,0	8	DK08080B53_FC	5xD	43	53	91
8,0	8	DK08080B76_FC	8xD	60	76	114
8,1	10	DK10081B47_FC	3xD	35	47	89
8,1	10	DK10081B61_FC	5xD	49	61	103
8,2	10	DK10082B47_FC	3xD	35	47	89
8,2	10	DK10082B61_FC	5xD	49	61	103
8,3	10	DK10083B47_FC	3xD	35	47	89
8,3	10	DK10083B61_FC	5xD	49	61	103
8,4	10	DK10084B47_FC	3xD	35	47	89
8,4	10	DK10084B61_FC	5xD	49	61	103
8,5	10	DK10085B47_FC	3xD	35	47	89
8,5	10	DK10085B61_FC	5xD	49	61	103
8,5	10	DK10085B87_FC	8xD	68	87	142
8,6	10	DK10086B47_FC	3xD	35	47	89
8,6	10	DK10086B61_FC	5xD	49	61	103
8,7	10	DK10087B47_FC	3xD	35	47	89
8,7	10	DK10087B61_FC	5xD	49	61	103
8,8	10	DK10088B47_FC	3xD	35	47	89
8,8	10	DK10088B61_FC	5xD	49	61	103
8,9	10	DK10089B47_FC	3xD	35	47	89
8,9	10	DK10089B61_FC	5xD	49	61	103
9,0	10	DK10090B47_FC	3xD	35	47	89
9,0	10	DK10090B61_FC	5xD	49	61	103
9,0	10	DK10090B87_FC	8xD	68	87	142
9,1	10	DK10091B47_FC	3xD	35	47	89
9,1	10	DK10091B61_FC	5xD	49	61	103
9,2	10	DK10092B47_FC	3xD	35	47	89
9,2	10	DK10092B61_FC	5xD	49	61	103
9,3	10	DK10093B47_FC	3xD	35	47	89
9,3	10	DK10093B61_FC	5xD	49	61	103
9,4	10	DK10094B47_FC	3xD	35	47	89
9,4	10	DK10094B61_FC	5xD	49	61	103
9,5	10	DK10095B47_FC	3xD	35	47	89
9,5	10	DK10095B61_FC	5xD	49	61	103
9,5	10	DK10095B95_FC	8xD	76	95	142
9,6	10	DK10096B47_FC	3xD	35	47	89
9,6	10	DK10096B61_FC	5xD	49	61	103
9,7	10	DK10097B47_FC	3xD	35	47	89
9,7	10	DK10097B61_FC	5xD	49	61	103
9,8	10	DK10098B47_FC	3xD	35	47	89
9,8	10	DK10098B61_FC	5xD	49	61	103
9,9	10	DK10099B47_FC	3xD	35	47	89
9,9	10	DK10099B61_FC	5xD	49	61	103
10,0	10	DK10100B47_FC	3xD	35	47	89
10,0	10	DK10100B61_FC	5xD	49	61	103
10,0	10	DK10100B95_FC	8xD	76	95	142
10,1	12	DK12101B55_FC	3xD	40	55	102
10,1	12	DK12101B71_FC	5xD	56	71	118
10,2	12	DK12102B55_FC	3xD	40	55	102
10,2	12	DK12102B71_FC	5xD	56	71	118
10,3	12	DK12103B55_FC	3xD	40	55	102
10,3	12	DK12103B71_FC	5xD	56	71	118
10,4	12	DK12104B55_FC	3xD	40	55	102
10,4	12	DK12104B71_FC	5xD	56	71	118
10,5	12	DK12105B55_FC	3xD	40	55	102
10,5	12	DK12105B71_FC	5xD	56	71	118
10,5	12	DK12105B106_FC	8xD	82	106	162
10,6	12	DK12106B55_FC	3xD	40	55	102

D mm	d mm	Part Number	Type	l mm	l <sub>2</sub> mm	L mm
10,6	12	DK12106B71_FC	5xD	56	71	118
10,7	12	DK12107B55_FC	3xD	40	55	102
10,7	12	DK12107B71_FC	5xD	56	71	118
10,8	12	DK12108B55_FC	3xD	40	55	102
10,8	12	DK12108B71_FC	5xD	56	71	118
10,9	12	DK12109B55_FC	3xD	40	55	102
10,9	12	DK12109B71_FC	5xD	56	71	118
11,0	12	DK12110B55_FC	3xD	40	55	102
11,0	12	DK12110B71_FC	5xD	56	71	118
11,0	12	DK12110B106_FC	8xD	82	106	162
11,1	12	DK12111B55_FC	3xD	40	55	102
11,1	12	DK12111B71_FC	5xD	56	71	118
11,2	12	DK12112B55_FC	3xD	40	55	102
11,2	12	DK12112B71_FC	5xD	56	71	118
11,3	12	DK12113B55_FC	3xD	40	55	102
11,3	12	DK12113B71_FC	5xD	56	71	118
11,4	12	DK12114B55_FC	3xD	40	55	102
11,4	12	DK12114B71_FC	5xD	56	71	118
11,5	12	DK12115B55_FC	3xD	40	55	102
11,5	12	DK12115B71_FC	5xD	56	71	118
11,5	12	DK12115B114_FC	8xD	90	114	162
11,6	12	DK12116B55_FC	3xD	40	55	102
11,6	12	DK12116B71_FC	5xD	56	71	118
11,7	12	DK12117B55_FC	3xD	40	55	102
11,7	12	DK12117B71_FC	5xD	56	71	118
11,8	12	DK12118B55_FC	3xD	40	55	102
11,8	12	DK12118B71_FC	5xD	56	71	118
11,9	12	DK12119B55_FC	3xD	40	55	102
11,9	12	DK12119B71_FC	5xD	56	71	118
12,0	12	DK12120B55_FC	3xD	40	55	102
12,0	12	DK12120B71_FC	5xD	56	71	118
12,0	12	DK12120B114_FC	8xD	90	114	162
12,5	14	DK14125B60_FC	3xD	43	60	107
12,5	14	DK14125B77_FC	5xD	60	77	124
12,5	14	DK14125B133_FC	8xD	125	133	182
13,0	14	DK14130B60_FC	3xD	43	60	107
13,0	14	DK14130B77_FC	5xD	60	77	124
13,0	14	DK14130B133_FC	8xD	125	133	182
13,5	14	DK14135B60_FC	3xD	43	60	107
13,5	14	DK14135B77_FC	5xD	60	77	124
13,5	14	DK14135B133_FC	8xD	125	133	182
14,0	14	DK14140B60_FC	3xD	43	60	107
14,0	14	DK14140B77_FC	5xD	60	77	124
14,0	14	DK14140B133_FC	8xD	125	133	182
14,5	16	DK16145B65_FC	3xD	45	65	115
14,5	16	DK16145B83_FC	5xD	63	83	133
14,5	16	DK16145B152_FC	8xD	138	152	204
15,0	16	DK16150B65_FC	3xD	45	65	115
15,0	16	DK16150B83_FC	5xD	63	83	133
15,0	16	DK16150B152_FC	8xD	138	152	204
15,5	16	DK16155B65_FC	3xD	45	65	115
15,5	16	DK16155B83_FC	5xD	63	83	133
15,5	16	DK16155B152_FC	8xD	138	152	204
16,0	16	DK16160B65_FC	3xD	45	65	115
16,0	16	DK16160B83_FC	5xD	63	83	133
16,0	16	DK16160B152_FC	8xD	138	152	204
16,5	18	DK18165B73_FC	3xD	51	73	123
16,5	18	DK18165B93_FC	5xD	71	93	143
17,0	18	DK18170B73_FC	3xD	51	73	123
17,0	18	DK18170B93_FC	5xD	71	93	143
17,5	18	DK18175B73_FC	3xD	51	73	123



with Internal Coolant, 3xD, 5xD, 8xD



D mm	d mm	Part Number	Type	l mm	l <sub>2</sub> mm	L mm
17,5	18	DK18175B93_FC	5xD	71	93	143
18,0	18	DK18180B73_FC	3xD	51	73	123
18,0	18	DK18180B93_FC	5xD	71	93	143
18,5	20	DK20185B79_FC	3xD	55	79	131
18,5	20	DK20185B101_FC	5xD	77	101	153
19,0	20	DK20190B79_FC	3xD	55	79	131
19,0	20	DK20190B101_FC	5xD	77	101	153
19,5	20	DK20195B79_FC	3xD	55	79	131
19,5	20	DK20195B101_FC	5xD	77	101	153
20,0	20	DK20200B79_FC	3xD	55	79	131
20,0	20	DK20200B101_FC	5xD	77	101	153



# CARBIDE RODS

## CONTENTS

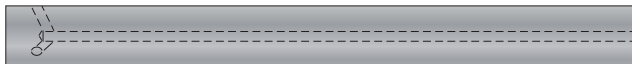

Carbide Rods	124	
Carbide Rods with Internal Axial Coolant	125	
Carbide Rods with Internal Radial Coolant	125	

## Carbide Blanks

SmiCut supplies carbide known for its high and consistent quality.

The round bars in SmiCut's stock have the following properties:

- Hard metal micrograin ( $0.7\mu$ )
- 10% Cobalt
- Ground and polished
- h6 tolerance
- Chamfered

They are also available with an internal axial coolant channel and internal radial coolant channel.

In addition, SmiCut provides rectangular carbide blanks, both ground and unground. Custom shapes and dimensions are also produced.



# CARBIDE RODS

## Round Blanks

**KXF**  
Micrograin Carbide  
0,7 $\mu$ , 10% Cobalt  
**Tolerance**  
h6, ground and polished

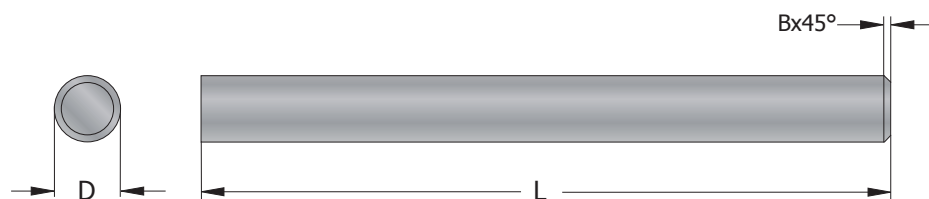

D mm	L mm	B mm	Part Number
3,0	39	0,3	Ø3X39_KXF
3,0	100	0,3	Ø3X100_KXF
3,0	320	0,3	Ø3X320_KXF
4,0	50	0,4	Ø4X50_KXF
4,0	100	0,4	Ø4X100_KXF
4,0	320	0,4	Ø4X320_KXF
5,0	100	0,4	Ø5X100_KXF
5,0	320	0,4	Ø5X320_KXF
6,0	63	0,4	Ø6X63_KXF
6,0	76	0,4	Ø6X76_KXF
6,0	100	0,4	Ø6X100_KXF
6,0	320	0,4	Ø6X320_KXF
8,0	63	0,5	Ø8X63_KXF
8,0	76	0,5	Ø8X76_KXF
8,0	100	0,5	Ø8X100_KXF
8,0	320	0,5	Ø8X320_KXF
10,0	76	0,5	Ø10X76_KXF
10,0	100	0,5	Ø10X100_KXF
10,0	320	0,5	Ø10X320_KXF
12,0	83	0,5	Ø12X83_KXF
12,0	100	0,5	Ø12X100_KXF
12,0	320	0,5	Ø12X320_KXF
14,0	89	0,8	Ø14X89_KXF
14,0	100	0,8	Ø14X100_KXF
14,0	320	0,8	Ø14X320_KXF
16,0	89	0,8	Ø16X89_KXF
16,0	100	0,8	Ø16X100_KXF
16,0	120	0,8	Ø16X120_KXF
16,0	320	0,8	Ø16X320_KXF
18,0	100	0,8	Ø18X100_KXF
18,0	130	0,8	Ø18X130_KXF
18,0	320	0,8	Ø18X320_KXF
20,0	100	1,0	Ø20X100_KXF
20,0	120	1,0	Ø20X120_KXF
20,0	150	1,0	Ø20X150_KXF
20,0	320	1,0	Ø20X320_KXF
25,0	100	1,0	Ø25X100_KXF
25,0	120	1,0	Ø25X120_KXF
25,0	130	1,0	Ø25X130_KXF
25,0	150	1,0	Ø25X150_KXF
25,0	320	1,0	Ø25X320_KXF
32,0	150	1,0	Ø32X150_KXF
32,0	320	1,0	Ø32X320_KXF
40,0	170	1,0	Ø40X170_KXF

# CARBIDE RODS

## with Internal Axial Coolant

**KXF**  
Micrograin Carbide  
0,7μ, 10% Cobalt  
**Tolerance**  
h6, ground and polished

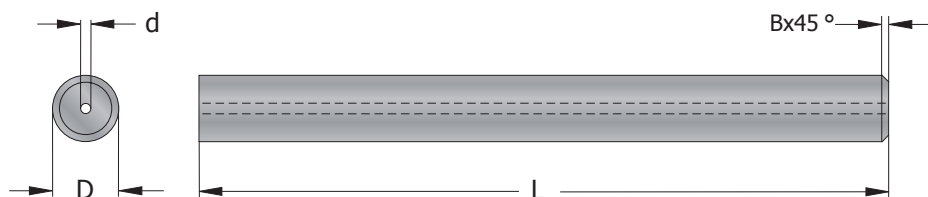

D mm	L mm	d mm	B mm	Part Number
4	50	0,6	0,4	Ø4X50Ø0.6_KXF
6	63	1	0,4	Ø6X63Ø1_KXF
8	76	1,3	0,5	Ø8X76Ø1.3_KXF
10	100	2	0,5	Ø10X100Ø2_KXF
12	100	2	0,5	Ø12X100Ø2_KXF
14	100	2	0,8	Ø14X100Ø2_KXF
16	120	3	0,8	Ø16X120Ø3_KXF
20	150	3	1,0	Ø20X150Ø3_KXF

## with Internal Radial Coolant

**KXF**  
Micrograin Carbide  
0,7μ, 10% Cobalt  
**Tolerance**  
h6, ground and polished

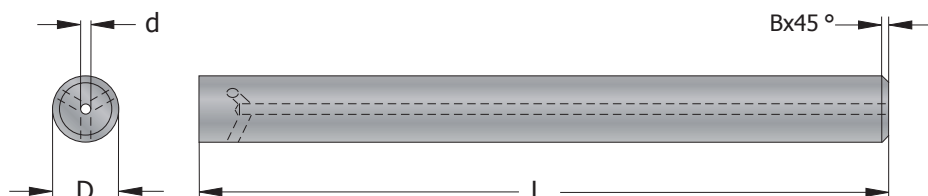

D mm	L mm	d mm	No. of holes	B mm	Part Number
6	76	1	3	0,5	Ø6X76Ø1C_KXF
8	76	1,2	3	1,0	Ø8X76Ø1.2C_KXF
8	76	1,2	4	1,0	Ø8X76Ø1.2D_KXF
10	100	1,2	3	1,0	Ø10X100Ø1.2C_KXF
10	100	1,2	4	1,0	Ø10X100Ø1.2D_KXF
12	100	1,5	4	1,0	Ø12X100Ø1.5D_KXF
12	100	1,5	5	1,0	Ø12X100Ø1.5E_KXF
16	100	1,5	4	1,5	Ø16X100Ø1.5D_KXF
16	100	1,5	5	1,5	Ø16X100Ø1.5E_KXF

■ SmiCut supply rectangular carbide rods

## Metric

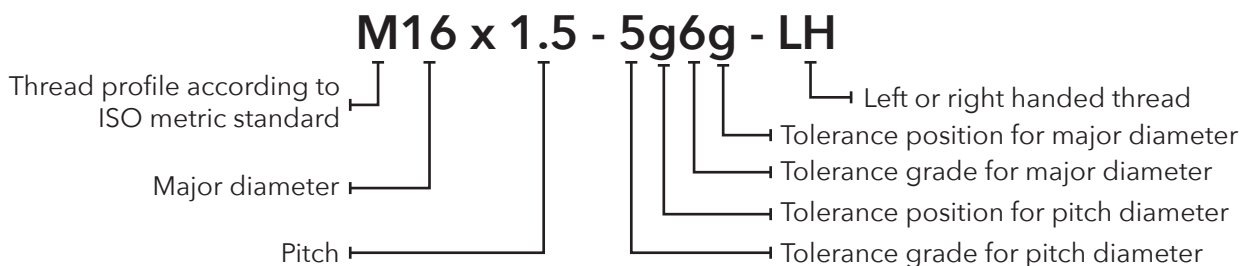

All types and tolerance classes can be produced with ISO metric thread turning and thread milling tools.

For coarse threads, the pitch is not written as it is determined of the diameter, for example M16 instead of M16 x 2.

If the tolerance grade and position is the same for pitch and major diameter, it is written only once, for example 6h instead of 6h6h. Small letter for external threads and capital letter for internal threads. If no tolerance class is written, it means that the tolerance is 6H/6g. Slash between tolerances provide information about the internal and external thread.

It is not necessary to write RH for right hand thread as almost all threads are right handed.

M16 is a simplified writing of M16 x 2 - 6H/6g - RH.

Major diameter mm			Pitch mm
Serie 1	Serie 2	Serie 3	
M1			0,25
	M1,1		0,25
M1,2			0,25
	M1,4		0,3
M1,6			0,35
	M1,8		0,35
M2			0,4
	M2,2		0,45
M2,5			0,45
M3			0,5
	M3,5		0,6
M4			0,7
	M4,5		0,75
M5			0,8
M6			1
		M7	1
M8			1,25
		M9	1,25
M10			1,5
		M11	1,5
M12			1,75
	M14		2
M16			2
	M18		2,5
M20			2,5
	M22		2,5
M24			3
	M27		3
M30			3,5
	M33		3,5
M36			4
	M39		4
M42			4,5
	M45		4,5
M48			5
	M52		5
M56			5,5
	M60		5,5
M64			6
	M68		6

### Thread Profile Depth

external	0,613 x pitch
internal	0,541 x pitch

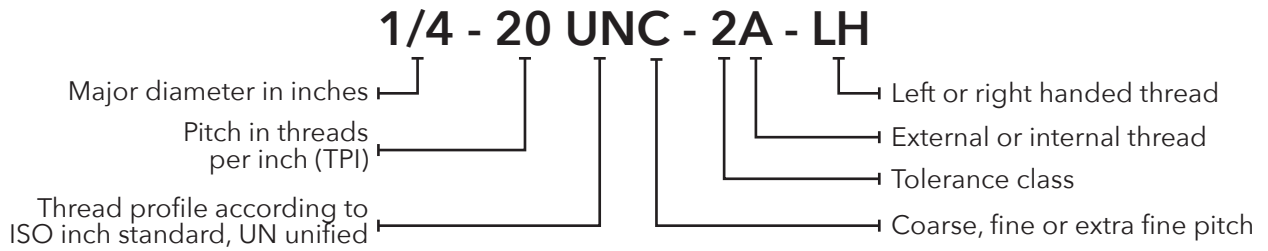

All types and tolerance classes can be produced with UN unified thread turning and thread milling tools.

When the thread is smaller than 1/4", the diameter is given with a number from No. 0 to No. 12 (No. # x 0.013" + 0.060").

Mostly, the pitch is not written as it is determined of the diameter for UNC, UNF and UNEF threads.

If no tolerance class is written, it means that the tolerance is 2A for external threads and 2B for internal.

It is not necessary to write RH for right hand thread as almost all threads are right handed.

1/4 - UNC is a simplified writing of 1/4 - 20 UNC - 2A/2B - RH.

UNC	thread with coarse pitch
UNF	thread with fine pitch
UNEF	thread with extra fine pitch
UN	thread with constant pitch

	external	internal
Loose tolerance	1A	1B
Medium tolerance	2A	2B
Tight tolerance	3A	3B

Thread Profile Depth	
external	15,581 / TPI
internal	13,748 / TPI

Thread	Diameter mm	Pitch TPI		
		UNC	UNF	UNEF
No. 0	1,524	-	80	-
No. 1	1,854	64	72	-
No. 2	2,184	56	64	-
No. 3	2,515	48	56	-
No. 4	2,845	40	48	-
No. 5	3,175	40	44	-
No. 6	3,505	32	40	-
No. 8	4,166	32	36	-
No. 10	4,826	24	32	-
No. 12	5,486	24	28	32
1/4	6,350	20	28	32
5/16	7,937	18	24	32
3/8	9,525	16	24	32
7/16	11,112	14	20	28
1/2	12,700	13	20	28
9/16	14,287	12	18	24
5/8	15,875	11	18	24
3/4	19,050	10	16	20
7/8	22,225	9	14	20
1	25,400	8	12	20
1 1/16	26,988	-	-	18
1 1/8	28,575	7	12	18
1 3/16	30,162	-	-	18
1 1/4	31,750	7	12	18
1 5/16	33,338	-	-	18
1 3/8	34,925	6	12	18
1 7/16	36,512	-	-	18
1 1/2	38,100	6	12	18
1 9/16	39,688	-	-	18
1 5/8	41,275	-	-	18
1 11/16	42,862	-	-	18
1 3/4	44,450	5	-	-
2	50,800	4 1/2	-	-
2 1/4	57,150	4 1/2	-	-
2 1/2	63,500	4	-	-
2 3/4	69,850	4	-	-
3	76,200	4	-	-
3 1/4	82,550	4	-	-
3 1/2	88,900	4	-	-
3 3/4	95,250	4	-	-
4	101,600	4	-	-

# THREAD DESIGNATIONS

## British Standard Pipe Thread

### G 1/2 A - LH



### G - Whitworth / BSPP (P=parallel) Pipe Thread

All types and tolerance classes can be produced with W (Whitworth) thread turning and thread milling tools.

	external	internal
Loose tolerance	A	only one
Tight tolerance	B	class

To get a pressure tight-joint you need a seal ring between the shoulder of the external thread and the face of the internal thread.

### R - Whitworth / BSPT (T=tapered) Pipe Thread

All types and tolerance classes of conical threads can be produced with BSPT threading tools.

Rp	Internal cylindrical pipe thread
Rc	Internal conical pipe thread
R	External conical pipe thread

As the thread is conical it will be almost a pressure tight-joint, but to improve the sealing effect you need to use a thread seal tape.

Pitch is not written as it is determined of the diameter.

It is not necessary to write RH for right hand thread as almost all threads are right handed.

Thread Profile Depth	
external	16,256 / TPI
internal	16,256 / TPI

Thread	Pipe diameter	Pitch TPI
1/16	7,723	28
1/8	9,728	28
1/4	13,157	19
3/8	16,662	19
1/2	20,955	14
5/8*	22,911	14
3/4	26,441	14
7/8*	30,201	14
1	33,249	11
1 1/8*	37,897	11
1 1/4	41,910	11
1 1/2	47,803	11
1 3/4*	53,746	11
2	59,614	11
2 1/4*	65,710	11
2 1/2	75,184	11
2 3/4*	81,534	11
3	87,884	11
3 1/2*	100,330	11
4	113,030	11
4 1/2*	125,730	11
5	138,430	11
5 1/2*	151,130	11
6	163,830	11

\*This dimension is only for G

# COMMON THREAD PROFILES

## ISO (M) and UN

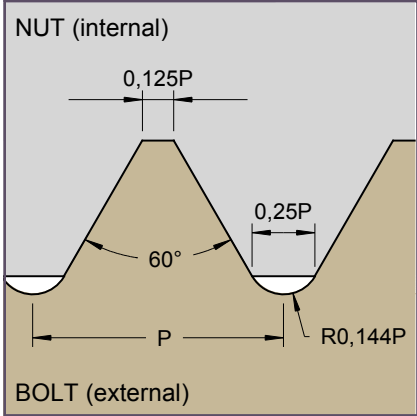

## Whitworth (W)

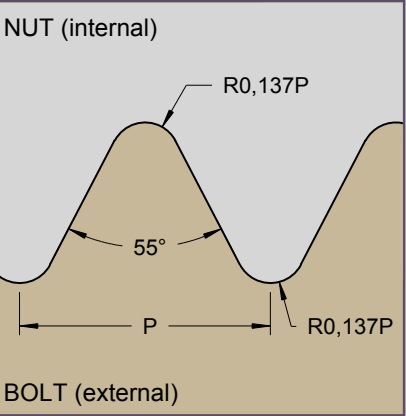

## BSPT

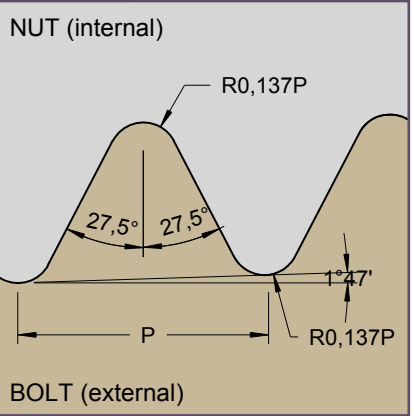

## MJ and UNJ

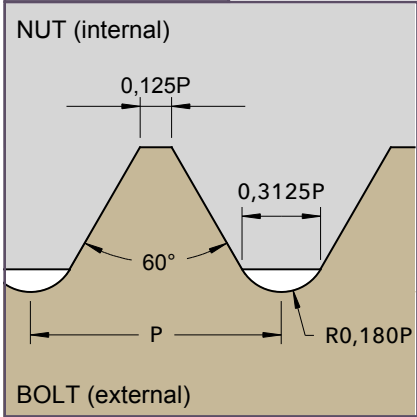

## NPT and NPTF

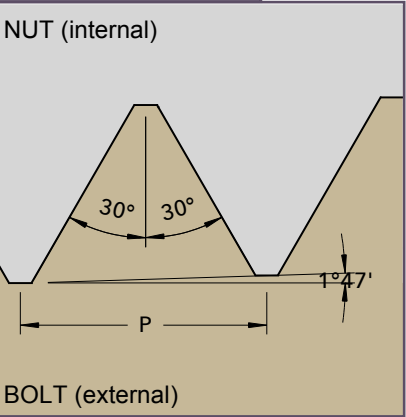

## NPSF

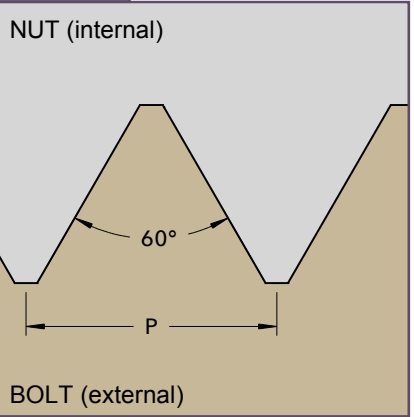

## Trapez DIN 103

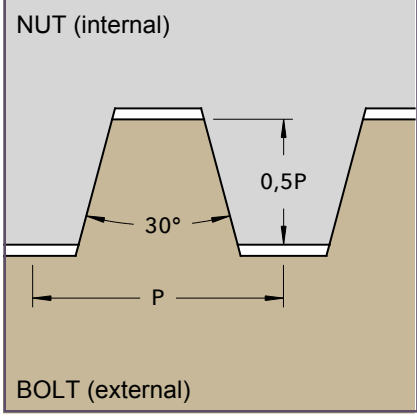

## ACME

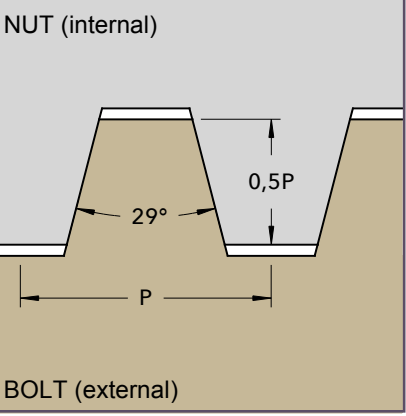

## STUB ACME

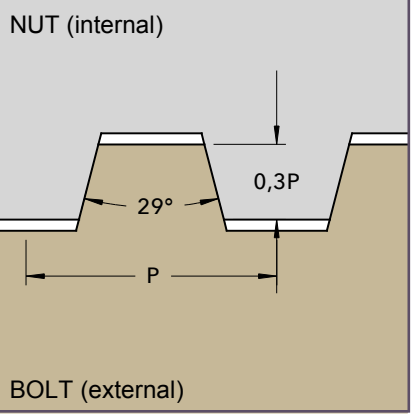

## Round DIN 405

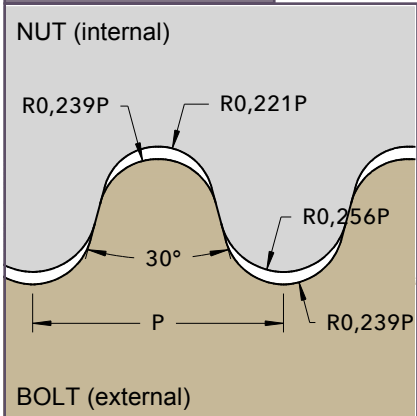

## PG DIN 40430

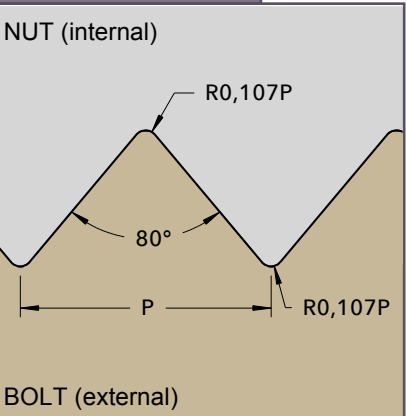

## SG DIN 513

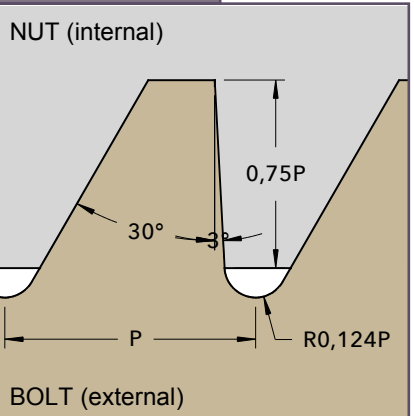





# SmiCut

*The Master of Threading*



**SmiCut Website**  
smicut.com



**LinkedIn**



**Online Store**  
smicut.store



**YouTube**



**SmiProg Online**  
Thread Milling Software

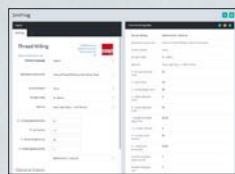

**SmiCut AB**

Fläderstigen 12, SE-771 43 Ludvika, Sweden

tel. +46 240 182 30 | info@smicut.se | www.smicut.com